



Auto Anchor



AutoAnchor 730

OWNER'S MANUAL

AutoAnchor 730 Owner's Manual

TABLE OF CONTENTS

| | | |
|---------------|------------------------------|-----------|
| Part 1 | Important Information | 2 |
| Part 2 | Installation | 4 |
| Part 3 | Set Up | 17 |
| Part 4 | Operation | 28 |
| Part 5 | Maintenance | 38 |
| Part 6 | Troubleshooting | 38 |
| Index | | 56 |

To the best of our knowledge the information in this manual was correct at the time of printing. However, the AutoAnchor products are continuously being reviewed and improved and product specifications may be changed without notice. The latest product specifications may not be reflected in this version of the manual. The documentation relating to the AutoAnchor products is created in the English language and may be translated from English to another language. In the event of any conflict between translated documents, the English language version will be the official version.

AutoAnchor documents are available on the website www.autoanchor.co.nz

PART 1 IMPORTANT INFORMATION

READ BEFORE INSTALLING OR USING THE AUTOANCHOR

- The AA730 should only be installed by a qualified marine electrician. Do not attempt to install the AA730 unless you are suitably qualified.
- This manual supports the use of the AA730 only. The appropriate manufacturer's instructions must be followed for the installation and use of the equipment the AA730 is set up to control.
- There must be an alternative method available to operate the windlass, thruster or other equipment.
- The AA730 can be fitted to most vertical windlasses. A horizontal windlass may require a sensor holder or a custom designed sensor which is not included in the standard pack. Check with your supplier or the AutoAnchor manufacturer.
- For chain counting the AA730 must be fitted to a windlass with a dual direction control box or solenoid pack.
- Information for installation and operation of the AA730 is supplied, including pre-set windlass profile lists, wiring diagrams, the Owner's Manual and the Quick User Guide. **All documents must be left on board for the owner.**
- Non compliance with the instructions could impair operation of the AA730, the windlass, thruster or other equipment and could result in personal injury and/or damage to the boat.
- Non compliance with the instructions will negate the manufacturer's warranty.
- The AA730 manufacturer and supplier accept no liability for personal injury or property damage resulting from failure to follow the installation and operation instructions or the use of the AA730 in a way that may cause accidents or damage or that may violate the law.
- All the technical and cable specifications must be checked and adhered to and wiring diagrams must be followed without modification.
- Before use the AA730 must be correctly set up for all the equipment it is to control and tested in a safe environment. The AA730 will not count correctly if the windlass selection is wrong or the windlass is not standard (eg it is installed with a different chainwheel or motor).
- All installations must be carried out in accordance with USCG, ABYC, NMMA and BMEA requirements.
- When this product reaches the end of its useful life it must be disposed of in accordance with local regulations.
- Information is also available on www.autoanchor.co.nz

TECHNICAL SPECIFICATIONS

| Parameter | AA730 Remote Console | AA703 Base Station |
|--|---|--------------------|
| Current Consumption | 100mA | 50mA |
| Power Supply | 12V/24V DC | |
| Maximum Voltage | 30V DC | |
| Output Maximum Current Draw | 12V DC: 3.5A 24V DC: 3.5A The system has internal current limiting and thermal shutdown. | |
| Output Minimum Current Draw | 12V DC: 10mA 24V DC: 20mA | |
| IP Rating | IP67 | |
| Operating Temperature Range | 23°F to 140°F (-5°C to 60°C) | |
| Outputs | 6 | |
| System Supports | 1 base station and 1 console. | |
| Rode - Chain Only | Stainless or galvanised steel. | |
| Rode - Rope and Chain | Must have a minimum of 10ft (3m) of chain. Chain must be galvanised steel. Rope should be a good quality, nylon anchor rope. Type 66 or equivalent. | |
| DC windlasses require a dual direction solenoid. | | |

ELECTROMAGNETIC COMPATIBILITY (EMC)

FCC Information:

This device complies with CFR47 Part 15 of FCC Rules for Class B equipment.

ESTI Information (CE):

This device meets the relevant standards set out in European Standard EN 60945:2002 for maritime navigation and radio communication equipment and systems. These standards are intended to provide reasonable protection against interference by other emission generating products on the boat. Compliance with these standards is no guarantee that interference will not occur in a particular installation. The installation instructions must be followed to minimise the potential for interference.

Note: If shielded cable is not used for the sensor connections this will compromise the EMC and may invalidate the warranty.

AA730 equipment (AA703 base station and AA730 remote console) must be installed at least 3ft (1m) away from any equipment transmitting or cables carrying radio signals eg VHF radios, modified sine wave inverters, cables and antennas or radar antennas; and at least 6ft (2m) away from any SSB equipment. AA703 cables must be installed at least 1.5ft (500mm) away from such items.

PART 2 INSTALLATION

2.1 INSTALLATION TO OPERATE A WINDLASS

2.1.1 MAGNET AND SENSOR INSTALLATION

PLEASE READ BEFORE COMMENCING INSTALLATION

Correct magnet and sensor installation is critical for successful AutoAnchor operation.

The AutoAnchor can be installed on vertical windlasses, drum winches and most horizontal windlasses. Installation differs depending on the windlass type and on the rode (all-chain or rope and chain). **Please follow the instructions for your windlass and rode.** If it is not possible to comply with these instructions please check with the AutoAnchor manufacturer or your supplier for other options or if you are not sure how to proceed.

See www.autoanchor.co.nz for contact information.

2.1.2 MAGNET INSTALLATION OVERVIEW

Check before starting. Your chainwheel may be prefitted with a magnet or predrilled ready for you to fit the magnet.

Magnet Polarity: Not relevant when using the grey AA sensor (#9067) or a reed switch sensor. If retrofitting, using the black AA sensor (#9008), the south pole (marked side) of the magnet must face the sensor.

Magnet Seal: Insert the magnet into the hole and cover it with a minimum of 1mm of epoxy to protect it against corrosion. See Fig 1 on page 7.

Magnet Size and Position: Refer to the instructions for your specific windlass type.

2.1.3 SENSOR INSTALLATION OVERVIEW

Vertical Windlasses: The sensor is fitted in the deckplate. Some deckplates are predrilled for the sensor. Others have a dimple or mark to show where the sensor should be fitted. If the windlass is not factory drilled, drill a hole 10.3mm (13/32") diameter through the windlass deckplate. See the instructions for your specific windlass type.

Horizontal Windlasses: Sometimes it is not possible to fit the sensor to a horizontal windlass or it may need to be fitted by the windlass manufacturer. **Before starting check with the AutoAnchor manufacturer or supplier that it is possible to fit the sensor to your windlass. You may need a special fitting.**

Drilling the Deck: Before drilling into the deck, ensure there is nothing below the deck that could be damaged and that any hole you drill will not weaken the boat's structure. Drill a hole 10.3mm (13/32") diameter through the deck. Ensure this hole is directly in line with the sensor hole in the deckplate.

Fitting the Sensor: Do not force the sensor into the hole. Hammering the sensor head can damage the internal electronics. Ensure the sensor head is positioned so that it will not be hit by the chainwheel or manual crank mechanism during windlass operation and that it is at least 300mm (1ft) away from the battery and motor cables. Secure the sensor using a good quality neutral cure silicone or a strong adhesive eg. Sikaflex 291 or 3M 5200.

Sensor Connection: The sensor is plugged direct into the AA703 base station. Do not leave the cable hanging loose, it must be tied in place with cable ties. Extension cable, gender changers and field connectors are available if required.

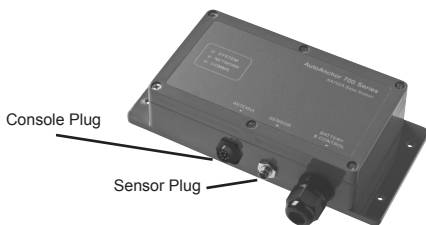

2.1.4 PLUG AND PLAY SENSOR CABLE

The AutoAnchor plug and play sensor cable is 2 core, tinned shielded cable. It must be used to connect the sensor to the console unit. Ensure the connectors are firmly screwed together.

The warranty does not apply if the sensor cable plugs are removed.

The sensor cable is fitted with a female plug to connect direct to the male connector on the AA703 base station. If a longer length is required, sensor connecting cable, with a male plug at each end, is available in the following lengths:

| | | |
|------|------------|------------|
| 6.5m | (21.33ft) | Part #9500 |
| 10m | (32.81ft) | Part #9501 |
| 15m | (49.21ft) | Part #9502 |
| 20m | (66.62ft) | Part #9503 |
| 25m | (82ft) | Part #9504 |
| 35m | (114.83ft) | Part #9514 |



A 2m male/female cable (Part #9505) plus a gender changer (Part #9510) will be required to connect the extension cable to the base station.

Connecting 2 cables together:



If you need to extend the cable length - 2 cables can be joined together using Part #9510 Gender Changer.

Field Connectors



Part #9507 Male Field Connector
Part #9508 Female Field Connector

If there is no plug on the sensor cable attach the AA field connector to the wires and use the connecting cable as above.

Dual Installation with Other AA Products

Use the T adaptor Part #9506 and the 2m Male/Female extension cable Part #9505.

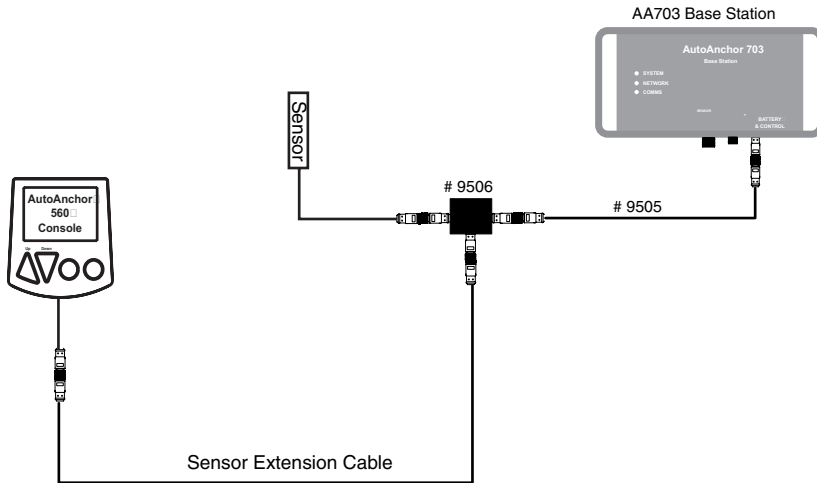

2.1.5 REED SWITCH SENSORS

Some windlasses are supplied pre-fitted with a reed switch sensor. Reed switch sensors must have a 10mm x 8mm magnet (#9061) and the gap between the reed switch sensor and the magnet must be a minimum of 3mm and a maximum of 5mm. This sensor requires a field connector.

The AutoAnchor will operate with a reed switch sensor for all-chain rode. If using combination rope and chain rode the reed switch sensor provides a reasonably accurate count of rode deployed but on retrieval the display may be incorrect because it cannot allow for the stretch in the rope.

For an accurate rope and chain count, the reed switch sensor should be replaced with the AA grey sensor (#9067).

2.1.6 SENSOR TUNING

When the AutoAnchor is completely installed the sensor must be tuned. See the instructions on page 30.

2.1.7 INSTALLATION ON A VERTICAL WINDLASS - CHAIN ONLY

Refer to the Overview Notes on page 4 before starting installation.

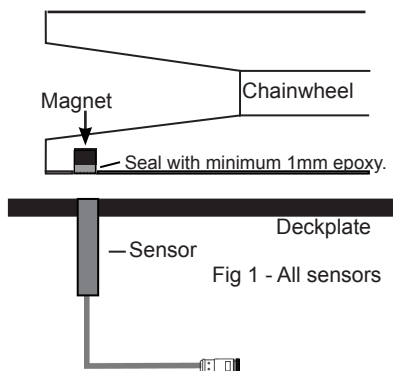

Note: If it is not possible to align the sensor and magnet exactly the AA grey sensor may be fitted up to 20mm out of alignment. The AA black sensor and the reed switch sensor must be directly aligned.

Magnet Size: Standard size is 10mm x 8mm (#9061). This may be replaced with the smaller 6mm x 4mm (#9009) magnet if required for your windlass.

Magnet Fit: Drill a hole 10.3mm (13/32") diameter and 9.5mm (3/8") deep to fit the magnet in the underside of a spoke in the bottom of the chainwheel. Cover the magnet with a minimum of 1mm epoxy. The magnet should be aligned with the sensor. See Fig 1.

Sensor Position: The AA black sensor and the reed switch sensor must be fitted directly in line with the magnet in the chainwheel. See Fig 1 above. The AA grey sensor may be fitted up to 20mm out of alignment. The gap between the sensor and magnet must be as per the table below.

Gap Between the Sensor and Magnet:

| Sensor | Magnet Size | Gap |
|-----------------------|-------------|----------------------------|
| AA Grey Sensor #9067 | 6mm x 4mm | Minimum 3mm - Maximum 30mm |
| AA Grey Sensor #9067 | 10mm x 8mm | Minimum 3mm - Maximum 50mm |
| AA Black Sensor #9008 | All Magnets | Minimum 3mm - Maximum 8mm |
| Reed Switch Sensor | 10mm x 8mm | Minimum 3mm - Maximum 5mm |

Sensor Connection: Ideally the sensor should be plugged directly into the AA703 base station. If longer cable is required use the AA 2m male/female extension cable (Part #9505) or one of the AA standard male/male extension cables plus the 2m cable and a gender changer. Ensure the connectors are firmly screwed together. See the information on page 5.

Loose cable should be tied in place with cable ties and kept clear of chain.

2.1.8 INSTALLATION ON A VERTICAL WINDLASS - ROPE & CHAIN

Refer to the Overview Notes on page 4 before starting installation.

For an accurate rope and chain count, the rode must run between the sensor and magnet. If your windlass is prefitted with a magnet in the bottom of the chainwheel you need to remove it and fit a new magnet in the top of the chainwheel. Refer to Figs 2-4.

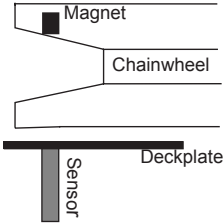

Fig 2

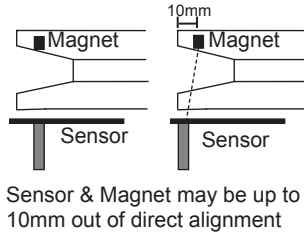

Fig 3

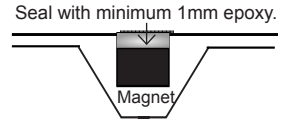

Fig 4

Magnet Size: 10mm X 8mm magnet (#9061). An 8mm x 6mm magnet (#9052) may be used on smaller windlasses. Check with your supplier.

Magnet Fit: Some windlasses are predrilled and others need a special fit. Please check with your supplier. The usual fit is as follows: Drill a hole 10.3mm (13/32") diameter and 9.5mm (3/8") deep into a spoke in the top of the chainwheel. Cover the magnet with a minimum of 1mm epoxy. The magnet and sensor must be aligned so that the anchor rode passes between them. See Figs 2 & 3.

Sensor Position: The sensor must be fitted into the deckplate within the sensor position range at the stern end of the windlass (See Fig 5). It must also be aligned with the magnet so that the rode passes between the sensor and the magnet. The centre of the magnet and the centre of the sensor may be up to 10mm out of direct alignment (See Fig 3). The gap between the sensor and magnet must be as per the table below.

Gap Between the Sensor and Magnet

| Sensor | Magnet Size | Gap |
|----------------------|-------------|-----------------------------|
| AA Grey Sensor #9067 | 8mm x 6mm | Minimum 30mm - Maximum 44mm |
| AA Grey Sensor #9067 | 10mm x 8mm | Minimum 35mm - Maximum 50mm |

Sensor Position Rope & Chain Vertical Windlasses

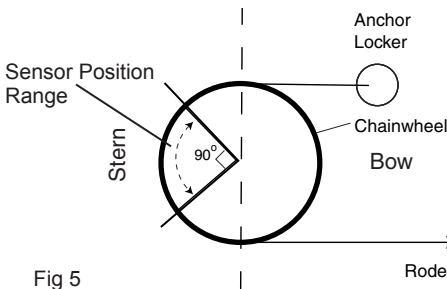

Fig 5

Sensor Connection: If longer cable is required the AutoAnchor plug and play sensor extension cable must be used to connect the sensor to the AA703 base station. Ensure the connectors are firmly screwed together. See the information on page 5.

Loose cable should be tied in place with cable ties and kept clear of chain.

2.1.9 INSTALLATION ON A HORIZONTAL WINDLASS - CHAIN ONLY

Refer to the Overview Notes on page 4 before starting installation. It is not possible to set out a single installation method for horizontal windlasses. The sensor may be fitted inside the windlass or you may need a sensor holder (Part #9110). See Fig 6 below. Often the sensor and magnet can only be fitted by the windlass manufacturer.

Magnet & Sensor Fitting for Chain Only Horizontal Windlasses

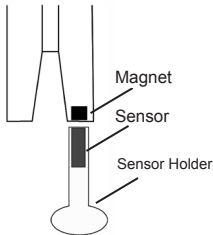

Fig 6
Magnet in rim of chainwheel and standard sensor in sensor holder screwed to the deck

Magnet Size: 6mm x 4mm magnet (#9009).

Magnet Fit: If your windlass is not predrilled drill a hole 6.5mm (1/4") diameter and 5mm (3/16") deep in the edge of the chainwheel. Cover the magnet with a minimum of 1mm epoxy.

Sensor Position: The AutoAnchor sensor may be fitted using a sensor holder fixed to the deck to sit under the chainwheel (See Fig 6). The AutoAnchor sensor holder (#9110) is not included in the standard kit. Check with your supplier if you need this. The AA black sensor and the reed switch sensor must be fitted directly in line with the magnet in the chainwheel. The AA grey sensor may be fitted up to 20mm out of alignment. The gap between the sensor and magnet must be as per the table below.

Gap Between the Sensor and Magnet:

| Sensor | Magnet Size | Gap |
|-----------------------|-------------|----------------------------|
| AA Grey Sensor #9067 | 6mm x 4mm | Minimum 3mm - Maximum 30mm |
| AA Grey Sensor #9067 | 10mm x 8mm | Minimum 3mm - Maximum 50mm |
| AA Black Sensor #9008 | All Magnets | Minimum 3mm - Maximum 8mm |
| Reed Switch Sensor | 10mm x 8mm | Minimum 3mm - Maximum 5mm |

Sensor Connection: If longer cable is required the AutoAnchor plug and play sensor extension cable must be used to connect the sensor to the AA703 base station. Ensure the connectors are firmly screwed together. See the information on page 5.

Loose cable should be tied in place with cable ties and kept clear of chain.

2.1.10 INSTALLATION ON A HORIZONTAL WINDLASS - ROPE & CHAIN

Before starting check with the AutoAnchor manufacturer, or supplier, that it is possible to fit the sensor and magnet to your horizontal windlass.

For an accurate rope count the rode must run between the sensor and magnet. On a horizontal windlass the magnet and sensor must be fitted by the windlass manufacturer.

If it is not possible to have the sensor and magnet fitted to achieve this you can use the chain only horizontal windlass installation above. **This provides an accurate count of rode deployed but during retrieval the display may be incorrect because it cannot allow for the stretch in the rope.**

2.1.11 INSTALLATION ON DRUM WINCHES

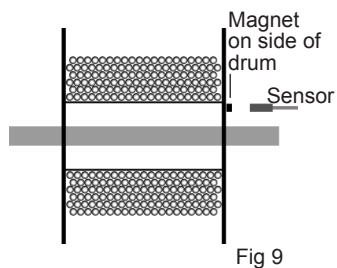
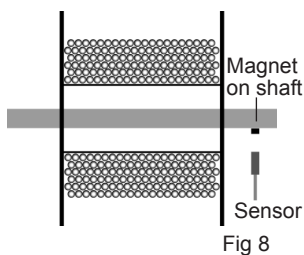
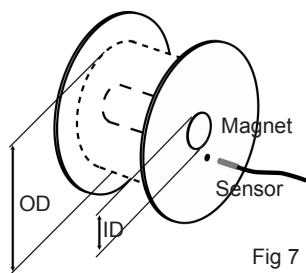

Gap Between the Sensor and Magnet:

Minimum 5mm and maximum 40mm.

The magnet and sensor must be fitted so that the gap remains consistent as the winch turns.

Magnet Installation:

Size: 10mm x 8mm magnet (#9061).

The magnet can be mounted on the main shaft or on the side of the drum. See Figs 8 and 9. If mounted on the side of the drum, position it close to the inside to reduce the peripheral speed of the magnet. Fix the magnet into position with epoxy ensuring it is completely sealed to prevent corrosion.

Sensor Installation

The Grey 3 wire AA sensor (#9067) is recommended but a proximity sensor may be used. Every installation is different so this manual can provide guidelines only. The AA sensor holder #9110, or a customised sensor holder will be required to ensure the sensor remains in position and the gap is consistent between the sensor and magnet during operation.

Sensor Connection: The AutoAnchor plug and play sensor extension cable must be used to connect the sensor to the AA703 base station. Ensure the connectors are firmly screwed together. See the information on page 5.

Loose cable should be tied in place with cable ties and kept clear of chain.

For Drum Winch Set Up and Operation Refer to Page 27.

2.2 INSTALLATION TO OPERATE A THRUSTER

Before connecting the AA730 to operate a thruster you must ensure that the thruster has been installed and tested by a qualified marine electrician and that the installation has been completed according to the thruster manufacturer's instructions.

Refer to the wiring diagram and notes supplied for the AA730.

An isolating switch must be installed for controls if the main breaker or isolator is not readily accessible from the helm.

If the thruster control circuit uses negative switching, connect a relay between the AA703 output and the control wire to convert from positive to negative switching.

The stern and bow output locations stated in the wiring are the default locations. These can be changed using the AA730 set up menu.

The thruster manufacturer's safety requirements for testing and operating the thruster must be adhered to at all times when using the AA730. These include but are not limited to:

- Never operate a thruster close to people swimming.
- Never run the thruster out of the water. Not even for a short period. Any operation of the thruster out of the water can seriously damage the motor.
- Running a thruster without resistance from the propeller can also cause serious damage to the motor.
- **If the thruster stops giving thrust while the motor is running, turn it off immediately.**

2.2.1 POWER ENABLE SETTING

This is used to activate a power pack. It will time out and switch off after the delay time selected.

2.3 INSTALLATION TO OPERATE AUXILIARY EQUIPMENT

Outputs from the AA730 can be connected to control auxiliary equipment on the vessel such as lights, deck or anchor wash, pumps, electric cleats and davits. Up to 4 auxiliary outputs can be set up per system.

Before connecting the AA730 to operate auxiliary equipment you must ensure that the equipment has been installed and tested by a qualified marine electrician and that the installation has been completed strictly according to the equipment manufacturer's instructions. The equipment must only be used according to the equipment manufacturer's instructions.

Refer to the wiring diagrams and notes supplied for the AA730.

An isolating switch must be installed for controls if the main breaker or isolator is not readily accessible from the helm.

Relays: If the auxiliary equipment is outside the specification of the AA703 output (eg current greater than 3.5A) relays will need to be interfaced between the AA703 output and the auxiliary equipment. This applies also if the auxiliary equipment is running off a different power supply.

2.4 CONSOLE AND BASE STATION INSTALLATION

The AA730 kit has one base station, one remote console with cradle, a deck socket with 2m lead, a socket sealing cap, screws for the cradle and socket and a drilling template. Each base station has 6 outputs.

2.4.1 BASE STATION INTERNAL CONNECTIONS

| AA703 Terminal | | Default Function Assignment | Alternative Function Assignment | |
|----------------|-----|--|---------------------------------|---|
| BATT | (-) | Ground | | |
| BATT | (+) | Positive | | |
| OUT 1 | (+) | ¹ Windlass Down | | Power Enable when dual thrusters selected |
| OUT 2 | (+) | ¹ Windlass Up | | |
| OUT 3 | (+) | ² Thruster A (Bow) Port | Windlass Option A | |
| OUT 4 | (+) | ² Thruster A (Bow) Starboard | Windlass Option B | |
| OUT 5 White | (+) | ² Thruster B (Stern) Port | Power Enable | ³ Rope/Chain Motor Load Wires |
| OUT 6 Brown | (+) | ² Thruster B (Stern) Starboard | Dual Speed | ³ Rope/Chain Motor Load Wires |

Notes:

Unused outputs are automatically assigned as auxiliary outputs. See Page 22 for more details. All outputs are active high (+).

¹ Only one windlass can be connected to a base station. 2 windlasses require 2 systems. The windlass outputs OUT1 and OUT2 are fixed, however, the control buttons for up and down can be swapped in the set up menu as can the location of the windlass (bow or stern).

² Stern and bow thruster output locations stated are the default locations. These can be swapped in the set up menu. The port and starboard directions for each output cannot be changed.

³ Only required for rope/chain counting
 OUT 5 = White Motor Load Wire
 OUT 6 = Brown Motor Load Wire

2.4.2 REMOTE CONSOLE INSTALLATION

The remote console is sealed to IP67. It is supplied with a cradle and a cover. Use the 2 screws supplied to mount the cradle on a flat surface where the unit will be protected from the environment when not in use. The cover should be used to protect the LCD.



2.4.3 BASE STATION

When operating a windlass, the base station should be mounted close to the windlass, in a position where:

- the lid can be removed easily during operation.
- the LED indicators can be seen during operation.
- the cables extend below the unit when fixed to the wall to avoid condensation entering through the cable gland.

To maintain the IP67 waterproof seal through the cable gland a tinned, marine grade multi core cable must be used and the base station must be mounted so that the cables extend below the unit when fixed to the wall.

2.4.4 DECK SOCKET

Position the socket so that it can be easily reached by the operator.

Choose a clean, smooth, flat location where the underside of the socket will not be exposed to water or humidity.

Allow sufficient space behind the socket for the passage of the cable to the base station.

Use the drilling template to mark the drill holes.

Before drilling ensure there is nothing behind the drilling area that could be damaged or weakened by drilling.

Ensure the seal sits directly under the socket base.

Put the cable and the flange through the hole.

Fix the socket in position with the 4 screws provided.

Plug the cable into the base station.

2.5 POWER SUPPLY



THE POWER SUPPLY MUST BE DISCONNECTED WHEN INSTALLING, CONNECTING OR CHANGING THE WIRING

12V or 24V DC power supply is required to the AA703 base station.

Check battery polarity before connecting power and ensure output terminals will not short.

Refer to the manufacturer's specifications for fuse/breaker, isolator and main power cable specifications for the equipment being controlled by the AA730.

Ensure any fuse/breaker on the control circuit has a rating applicable to the current loads connected to the outputs. (AA703 Output maximum is 3.5 Amps). An additional isolating switch should be installed for controls if the main breaker or isolator is not readily accessible from the helm.

Multiple battery bank negative terminals must be permanently connected together to become the common negative return (ground).

2.5.1 WINDLASS INSTALLATIONS

Power supply to the AA703 base station must be from the windlass control circuit, along with all other windlass controls eg. toggle switch, remote switches, deck switches, other AutoAnchor devices. **Power supply must not be from the motor positive near the windlass.**



2.6 VOLTAGE LEVELS

Neither the windlass nor the AutoAnchor will operate with insufficient power. (See minimum voltages below). Batteries must be properly maintained and charged and all connections and wires must be of good quality and the correct gauge to prevent voltage drop.

| Minimum Voltage Required | 12V DC System | 24V DC System |
|---|---------------|---------------|
| Minimum voltage required to start windlass | 10V DC | 20V DC |
| If the windlass is already operating, this is the minimum voltage required to continue operating. | 6V DC | 12V DC |

2.7 WIRING

| CABLE SPECIFICATIONS | |
|---|----------------------------|
| An appropriate multi-core cable must be used to maintain the cable gland seal into the base station. | |
| Total Length | Cable Size |
| Cable from AA703 Base Station to the Power Supply | |
| Less than 8m (26ft) | 1.5mm ² (AWG16) |
| 8m (26ft) - 11m (36ft) | 2.0mm ² (AWG14) |
| 11m (36ft) - 17m (56ft) | 2.5mm ² (AWG12) |
| Cable from AA703 Base Station to Outputs | |
| Less than 10m (33ft) | 1.5mm ² (AWG16) |
| 10m (33ft) and 20m (66ft) | 2.0mm ² (AWG14) |
| 20m (66ft) and 40m (132ft) | 2.5mm ² (AWG12) |
| Cable from Motor Load Wires | |
| Up to 30.5m (100ft) | 1.0mm ² (AWG18) |

Interlock protection is included in the system. Do not fit diodes or interlock devices to outputs as these will prevent the system from operating correctly.

All battery and motor cables must be ring type, insulated to prevent short circuits and installed no closer than 1ft (300mm) away from the sensor head.

To reduce the potential for interference all cables must be located at least 1.5ft (500mm) away from any equipment transmitting or cables carrying radio signals eg VHF or SSB radios, cables and antennas or radar antennas.

Do not leave cables hanging loose, they must be tied in place with cable ties.

2.7.1 MOTOR LOAD WIRES (BROWN AND WHITE) OUTPUTS 5 & 6

Rope & Chain Counting: The brown and white wires must be connected direct to the windlass motor terminals for rope & chain counting. **A 1000 Ohm resistor must be fitted near the motor terminal** for short circuit protection. The motor load terminators supplied in the kit have motor terminal connectors with a 1000 Ohm resistor prefitted. If the AA730 is fitted to an **all-chain windlass**, a thruster or auxiliary equipment. Outputs 5 and 6 can be used for other options.

2.7.2 MULTIPLE AUTOANCHOR INSTALLATIONS

It is important when wiring multiple AutoAnchor products that potential differences do not occur along the ground connection. This can cause incorrect counting. Ensure AA560 and AA150 consoles and AA703 base stations are star grounded, and that there are no other high current paths between consoles. **All wiring for multiple installations is run in parallel.** Refer to wiring diagrams for further details.

2.7.3 CONNECTION TO LOW CURRENT DRIVES

When connecting to equipment with solid state switching or other low current drives, eg PLC or AC variable frequency, a dummy resistor load (Part # 9083) may be required to provide sufficient loading and to meet EMC and safety considerations. The resistor pack should be installed close to the equipment control **not on the AA703 base station.**

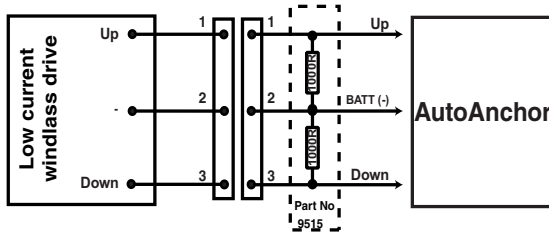

2.7.4 PLUG & PLAY SENSOR CONNECTIONS

The AA703 Base Station and the sensor are prefitted with connector plugs. The 2m sensor cable plugs direct into the base station. Extension cables are available. See page 5 for plug and play sensor cable information.

2.7.5 CONNECTING THE CABLES INTO THE BASE STATION

Remove the lid from the AA703 base station. Feed the multi-core cable through the waterproof gland. Connect the cables to the terminal block, using a screwdriver to press down and open each terminal as required. (See the photograph below). Tighten the cable gland. Replace the lid.

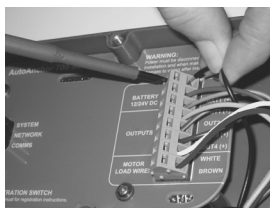

2.7.6 WIRING DIAGRAMS FOR AA703 BASE STATION

Wiring diagrams are included in the kit. Please refer to them for wiring detail. These diagrams and installation help are also available on www.autoanchor.co.nz

PART 3 SET UP

The AA730 system must be calibrated for the equipment it is to control on the boat. The AA730 must be tested with all the equipment it is to control to ensure it is working correctly.

3.1 USING THE AUTOANCHOR BUTTONS



On.



Scroll: Menu/Numbers/Up/Down.



Mode/Select/Enter/Save.



Escape or Back.



Hold together to access the Set up menu.



Hold for 2 seconds to disable the lock.



Hold for 1 second to toggle between modes eg windlass to thruster.



Control the windlass.



Control Options A & B, Thruster and Auxiliary outputs.



Hold for 6 seconds to turn off.

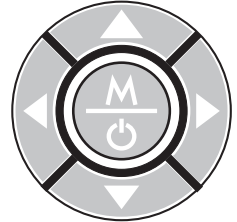

3.1.2 LED INDICATORS

- **System (Red)**
Steady red indicates power is on. Flashing a slow pulse indicates sensor is connected when the windlass is turning.
- **Network (Green)**
Steady green indicates the base station is ready.
- **Comms (Yellow)**
Flashing indicates data is received.

Note: The AA730 remote console automatically turns off after 5 minutes without use.

3.2 RESETTING FACTORY DEFAULTS - Clears all settings

Unplug the console. Turn on the power to the base station only. Open the base station and hold down the registration button for 15 seconds until all three LED's flash. This indicates the base station has performed a complete factory reset and all settings have reverted to the defaults. Follow the instructions on the next pages to set up the system again.

3.3 SET UP MENU OVERVIEW

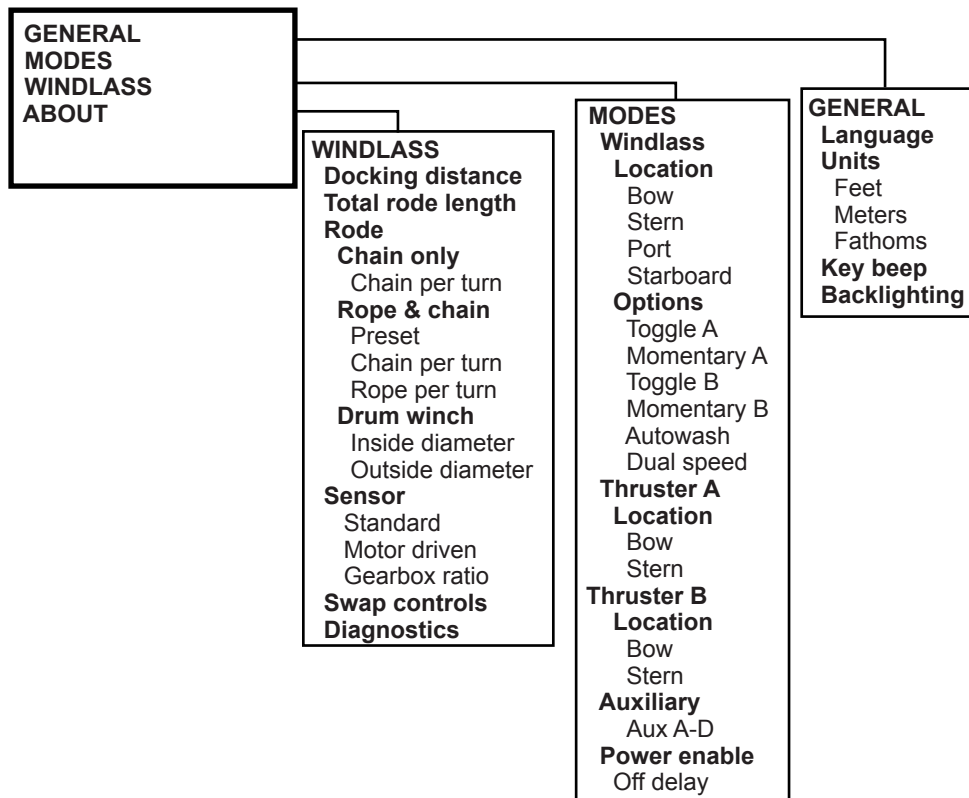

3.4 GENERAL SET UP

To access the Set up Menu the AA703 base station must be powered up with the AA730 remote console plugged in and turned off

- Hold together to display the Set up menu.
- Select General.

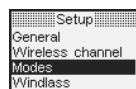

3.4.1 SET LANGUAGE - Default: English

- Select Language.
- Scroll to the language required.
- Save.
- Return to the General Menu.

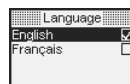
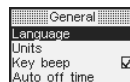

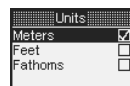
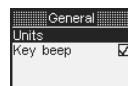

3.4.2 SET UNITS - Default: Meters

- Select units.
- Scroll to select meters, feet or fathoms.
- Save.
- Return to the General Menu.





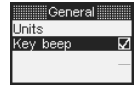

3.4.3 SET KEY BEEP - Default: Beep On

-  Scroll to Key beep.
-  Save Key beep on or off.
-  Return to the Set up Menu.



3.4.4 SET BACKLIGHTING

-  Scroll to Backlighting.
-  Select Backlighting.
-  Change Backlighting
-  Save and Return to General Menu
-  Return to Set up Menu.



3.5 MODES SET UP



The AA703 base station must be powered up and the AA730 remote console must be turned off to access the Set up Menu.

The AA730 system can be set up to operate your choice of equipment on the boat. The kit has one base station and one console. Each base station has 6 outputs. The default system is 1 windlass located on the bow. The options available are explained below, followed by examples of system setups. See also the table of output options on page 20.

3.5.1 WINDLASS SETTINGS

Allocate the outputs for windlasses and anchoring operations in the Modes menu.

3.5.1.1 Windlass Location - Outputs 1 and 2

An individual system is required for each windlass. The windlass outputs must be Output 1 and Output 2. The outputs are operated using the up  and down  buttons.

3.5.1.2 Windlass Options - Outputs 3 and 4

Option A and B can be used from the Windlass page for functions associated with anchoring. For example: decklights, deck wash, anchor stow, power cleat.

Option A is operated using the left arrow  button and controls Output 3.

Option B is operated using the right arrow  button and controls Output 4.

Both options can be set as momentary or toggle switches.

3.5.1.3 Autowash - Output 5

Turns on the anchor wash pump automatically when the anchor is retrieved.

3.5.1.4 Dual Speed - Output 6

Use to operate a windlass with a dual speed motor. Dual speed is controlled by the right arrow  button and sends a Fast/Slow signal to Output 6.

3.5.2 THRUSTER SETTINGS - Outputs 3, 4, 5 and 6

| | |
|--------------------------------------|---|
| Thruster A Default Location Bow | Output 3 - Port Output 4 - Starboard |
| Thruster B Default Location Stern | Output 5 Port Output 6 - Starboard |

The default locations can be swapped in the Setup menu. The port and starboard directions for each output cannot be changed.

Allocate the outputs and set the thruster location in the Modes menu. The thrusters are operated from the thruster page using the left ◀ and right ▶ arrow buttons.

3.5.3 AUXILIARY SETTINGS - All Outputs

Any spare output can be used as an auxiliary output with a **maximum of 4 per system**. These outputs can be used to operate any equipment on the boat that requires switching for example, to open and close transom doors or hatches, operate electric motors for cleats, to raise and lower davits, to switch on lights and pumps. The auxiliary outputs are operated in the auxiliary menu. Any button can be allocated to an auxiliary output. Switches can be momentary or toggle. Allocate the outputs for auxiliary equipment in the Modes menu.

3.5.4 POWER ENABLE - Output 1 or Output 5

This output is used to turn on the power pack or signal PLC systems. It is automatically triggered when the AA730 is used to control equipment connected to the system such as a windlass or a thruster. The signal is active high. Output 1 is used for a dual thruster system. Output 5 is used all other systems.

Power Enable Off Delay - Default 5 minutes

The Off Delay is adjustable from 0-60 minutes. Adjust to your requirements.

Access Power Enable through the Modes menu.



Select Modes in the Set Up Menu

The screen will show the Modes menu.



Select Power enable.



Select Off delay.



Adjust the Off delay time to meet your requirements.



Save and press ◀ 3 times to return to the Setup menu.

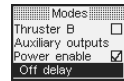

3.6 ALLOCATE MODES (FUNCTIONS) TO THE AA703 BASE STATIONS

After the AA703 base stations have been connected to the equipment the console must be set up to operate it. Follow the instructions below:

Turn the AutoAnchor off



Hold together to display the Setup menu.



Scroll to Modes.



Select Modes.

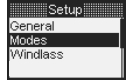

3.6.1 BASE STATION OUTPUTS

| AA703 Terminal | | Default Function Assignment | Alternative Function Assignment | |
|----------------|-----|--|---------------------------------|---|
| BATT | (-) | Ground | | |
| BATT | (+) | Positive | | |
| OUT 1 | (+) | ¹ Windlass Down | | Power Enable when dual thrusters selected |
| OUT 2 | (+) | ¹ Windlass Up | | |
| OUT 3 | (+) | ² Thruster A (Bow) Port | Windlass Option A | |
| OUT 4 | (+) | ² Thruster A (Bow) Starboard | Windlass Option B | |
| OUT 5 White | (+) | ² Thruster B (Stern) Port | Power Enable | ³ Rope/Chain Motor Load Wires |
| OUT 6 Brown | (+) | ² Thruster B (Stern) Starboard | Dual Speed | ³ Rope/Chain Motor Load Wires |

Notes:

Unused outputs are automatically assigned as auxiliary outputs. See Page 22 for more details. All outputs are active high (+).

¹ Only one windlass can be connected to a base station. 2 windlasses require 2 systems. The windlass outputs OUT1 and OUT2 are fixed, however, the control buttons for up and down can be swapped in the set up menu as can the location of the windlass (bow or stern).

² Stern and bow thruster output locations stated are the default locations. These can be swapped in the set up menu. The port and starboard directions for each output cannot be changed.

³ Only required for rope/chain counting

OUT 5 = White Motor Load Wire

OUT 6 = Brown Motor Load Wire

A system with one base station (6 outputs) can operate:

- 1 windlass plus a thruster and 2 optional functions eg a deck wash, deck light, anchor stow or electric cleat.
- 1 dual speed windlass, plus a thruster with power enable.
- or 1 windlass plus 4 auxiliary functions.
- or 1 windlass plus 2 thrusters.
- or 4 auxiliary outputs.

Example system setups are overleaf.

EXAMPLE 1

A windlass, Option A (anchor light) and Option B (manual anchor wash).



Select Modes In the Set Up Menu

Windlass



Select Windlass.



Select Location.



Scroll to the windlass location.



Select the windlass location.



Return to Modes.

Options



Select Options.



Select Toggle A for the anchor light.



Select Toggle B for manual anchor wash.



Return to Modes.



Press 3 times to return to the start screen.

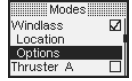
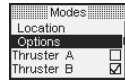
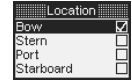
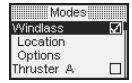
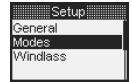

EXAMPLE 2

A dual speed windlass, a bow thruster with power enable.



Select Modes in the Set Up Menu

Windlass

Follow the steps in example 1 above for the windlass settings.

Under Options select dual speed.



Return to Modes.

Thruster



Scroll to Thruster.



Select Thruster.



Select Location.



Scroll to the thruster location.



Select the thruster location.



Return to Modes.



Select Power enable.



Select Off delay.



Adjust the Off delay time to meet your requirements.



Press 3 times to return to the start screen.

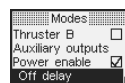
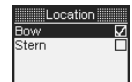
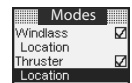
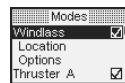
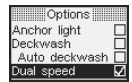
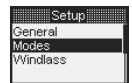

EXAMPLE 3 - AUXILIARY EQUIPMENT

Example set up is for a windlass, Option A (light) and autowash plus auxiliary equipment such as a cleat. The system automatically allocates spare outputs for use as auxiliaries.



Select Modes in the Set Up Menu

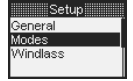

Windlass

Follow the steps in example 1 above for the windlass settings.

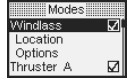

Return to the Modes screen.

Auxiliary Equipment

Select Auxiliary outputs. The screen displays the Auxiliary Outputs available. In this example there are 2 auxiliary outputs. Both outputs are currently disabled. Select the Auxiliary Output to set up. eg Output 3. The screen shows the key logic options. At present the Output is disabled.

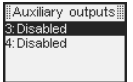
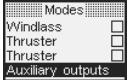

Select the Key Logic required for the auxiliary equipment:

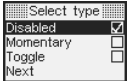

Momentary - Hold the button down for activity.

Toggle - Press and release the button to turn on the equipment and press and release again to turn off.



Scroll to Next and then select Next.

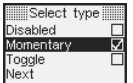

The screen shows the operating keys. Press the console key you wish to use for the auxiliary output. In this example the left arrow key will operate Output 3.



Press the mode button to select this key and return to the Auxiliary output screen. Output 3 is now listed as Aux C. See the Auxiliary Key References below.

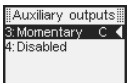

Scroll to and select the next Auxiliary output and repeat the instructions above to select the Key logic and the operating key for the next Auxiliary output.



Press 4 times to return to the operating screen.

Auxiliary Key References

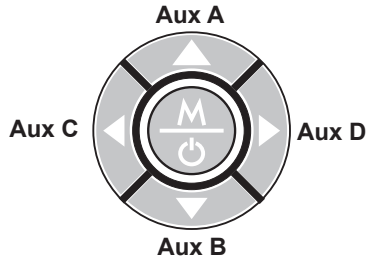



3.7 WINDLASS SET UP FOR CHAIN COUNTING

For accurate chain counting you must set up the AutoAnchor with the following information for your windlass.

3.7.1 TO ACCESS THE WINDLASS SET UP

Turn the AA730 remote console off.

-  Hold together to access the Set up menu.
-  Scroll to Windlass.
-  Select Windlass.

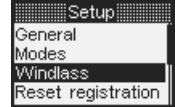





3.7.2 SET DOCKING DISTANCE

Setting: _____

Note: If the dual speed option is enabled the windlass will be in slow speed from this point.

Default = 1.5m or 4ft. Minimum setting = 1m or 3.3ft.
This is the point during retrieval when the windlass will stop.
Complete retrieval using manual operation.



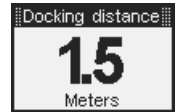
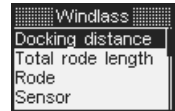

-  Scroll to Docking distance.
-  Select docking distance.
-  Increase or decrease the docking distance.
-  Save and return to Windlass Setup.



3.7.3 SET TOTAL RODE LENGTH

Setting: _____

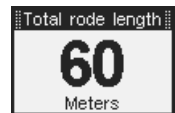
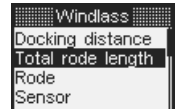

Add total length of chain plus total length of rope
Default = 60m or 196ft. Minimum setting = 10m (33ft)
or **OFF to operate as a counter only.**

-  Scroll to Total rode length.
-  Select Total rode length.
-  Increase or decrease the value in meters or feet.
-  Save and return to Windlass Set up.



3.7.4 SET RODE

Setting: _____

-  Scroll to Rode.
-  Select Rode.
-  Select "Chain only" or "Rope and chain" and follow the instructions below to enter the settings for the rode selected.

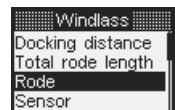

3.8 CHAIN ONLY RODE SET UP

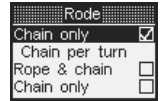

3.8.1 CHAIN PER TURN

This is the length of chain that is released during one complete turn of the chainwheel. The information for some windlasses is listed in Appendix 1. If your windlass is not listed follow the instructions below.

3.8.2 TO ENTER THE CHAIN PER TURN FOR CHAIN ONLY RODE

Setting: _____



Select Chain per turn.



Enter the measurement. In mm or in metric inches (depending on units selected). See the table below for metric inch calculations.



Save and return to Rode Set up.



Exit to Windlass Set up.

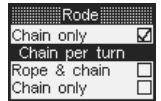

3.8.3 CALCULATING THE CHAIN PER TURN

- Step 1* Use adhesive tape to place a mark on the chainwheel.
- Step 2* Use adhesive tape to place a mark on the chain coming out of the chain wheel.
- Step 3* Use adhesive tape to place a mark on the deck below the mark on the chain.
- Step 4* Carefully release the chainwheel so that it can be turned by hand to feed the chain out.
- Step 5* Using the mark on the chainwheel as a guide, turn the chainwheel one complete turn, causing the chain to be released on to the deck.
- Step 6* Measure the length of chain from the mark on the deck to the mark on the chain.
- Step 7* Enter this measurement. (See below).

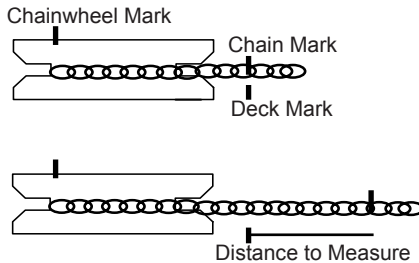

Metric Inches Conversion Table

| Inches | Metric Inches | AutoAnchor Setting (to 1 decimal point) |
|--------|---------------|--|
| 1/8 | 0.125 | 0.1 |
| 1/4 | 0.25 | 0.3 |
| 3/8 | 0.375 | 0.4 |
| 1/2 | 0.5 | 0.5 |
| 5/8 | 0.625 | 0.6 |
| 3/4 | 0.75 | 0.8 |
| 7/8 | 0.875 | 0.9 |

3.9 ROPE AND CHAIN RODE SET UP

Some rope and chain windlasses have the settings already entered in the AutoAnchor. Refer to the Preset Windlass Profile List in Appendix 1. If your windlass is on the list select "Use preset" to enter the Windlass profile.

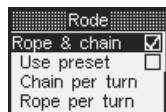







If your windlass is not on the list: You will need to enter information for the chain and rope per turn. See the instructions below.

3.9.1 SELECTING USE PRESET

Setting: _____

Refer to the Preset Windlass Profile List in Appendix 1.

-  Select Use Preset.
-  Scroll to Select preset.
-  Select preset.
-  Scroll to the correct preset windlass profile for your windlass.
-  Save and return to Rode Set up.
-  Exit to Windlass Set up.
-  Press to exit to the Set Up menu and press again to return to the start screen.





3.9.2 CHAIN PER TURN FOR ROPE AND CHAIN RODE

This is the length of chain that is released during one complete turn of the chainwheel. The chain per turn for some windlasses is listed in Appendix 1. **If your windlass is not listed follow the instructions on page 24 to calculate the chain per turn.**

3.9.3 TO ENTER THE CHAIN PER TURN FOR ROPE AND CHAIN RODE

Setting: _____

-  Select Chain per turn.
-  Enter the measurement in mm or metric feet (depending on the units selected). See the table above for metric inch calculations.
-  Save and return to Rode Set up.



3.9.4 ROPE PER TURN FOR ROPE AND CHAIN RODE

This is the length of rope that is released during one complete turn of the chainwheel. You need to measure the length of rope pulled through for 10 turns and divide the result by 10. **See instructions below to calculate the rope per turn.**

3.9.5 CALCULATING THE ROPE PER TURN

- Step 1* Carefully release the chainwheel so that it can be turned by hand to feed the rode out until you have rope.
- Step 2* As you did for the chain, use adhesive tape to mark the chainwheel, the deck and the rope. (See the instructions for the chain per turn on page 24).

Step 3 Using the mark on the chainwheel as a guide, pull the rope out by hand until the chainwheel has completed 10 turns.

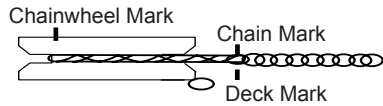

Step 4 Measure the length of rope pulled, divide it by 10.

Step 5 Enter this measurement (See below).

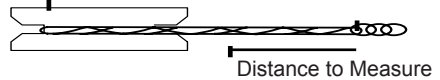

3.9.6 TO ENTER THE ROPE PER TURN

Setting: _____

- Select Rope per turn.
- Enter the measurement in mm or metric inches (depending on the units selected). See the table above for metric inch calculations.
- Save and return to Rode Set up.
- Exit to Windlass Set up.
- Press to exit to the Set Up menu and press again to return to the start up screen.

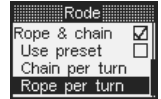

3.10 DRUM WINCH SET UP

Access via the Windlass Set Up Menu. 3 settings are required:

Total Rode Length.

Inside Diameter.

Outside Diameter with rode retrieved.

3.10.1 TO ACCESS THE WINDLASS SET UP

Turn the AA730 remote console off.

- Hold together to access the Set up menu.
- Scroll to Windlass.
- Select Windlass.



3.10.2 SET TOTAL RODE LENGTH

Setting: _____

Add total length of chain plus total length of rope
Default = 60m or 196ft. Minimum setting = 10m (33ft).

- Scroll to Total rode length.
- Select Total rode length.
- Increase or decrease the value in meters or feet.
- Save and return to Windlass Set up.

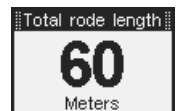
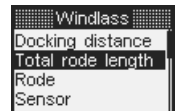

3.10.3 SET RODE

Setting: _____

- Scroll to Rode.
- Select Rode.
- Select Drum winch.

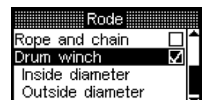

3.10.4 TO ENTER THE INSIDE AND OUTSIDE DIAMETER

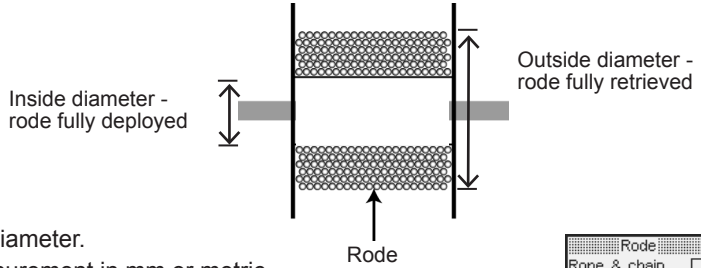

- Select Inside diameter.
- Enter the measurement in mm or metric inches (depending on the units selected).
- Save and return to Drum winch set up.
- Repeat for Outside Diameter.
- Exit to Windlass set up menu.
- Press again for the Set up Menu and again to return to start screen.

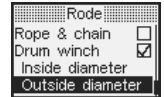

Inside Diameter: _____

Outside Diameter: _____

3.11 SENSOR SET UP

Default setting: **Standard - Applies to all AA sensors, reed switch baseplate sensors and proximity sensors.** The default setting should only be changed if you are using a motor driven sensor. (See below).

Note: The sensor is tuned to the system on first use. See page 30.

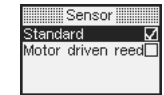
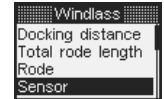

3.11.1 MOTOR DRIVEN SENSORS

To select the motor driven sensor:

- Scroll to Sensor.
- Select Sensor.
- Select Motor Driven Reed.
- Select Gearbox ratio.
- Increase or decrease the Gearbox ratio.
- Save and exit to the Sensor set up menu.
- Exit to the Windlass set up menu.
- Press again for the Set up Menu and again to return to start screen.

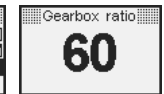
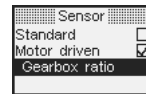
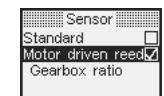
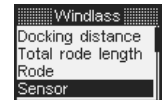

3.12 SWAP CONTROLS

Default setting: = Up and = Down.

Some operators prefer to use these buttons so that:

= Out and = In

Access the swap controls feature via the Windlass Set up Menu.

- Turn the AutoAnchor Off.
- Hold together to access the Set up menu.
- Select Windlass.
- Select Swap Controls.
- Exit to the Set Up Menu or press again for the start screen.

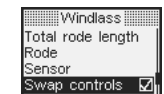

Note: This feature can not be used to correct wiring errors.

PART 4 OPERATION

4.1 INFORMATION DISPLAYED DURING OPERATION

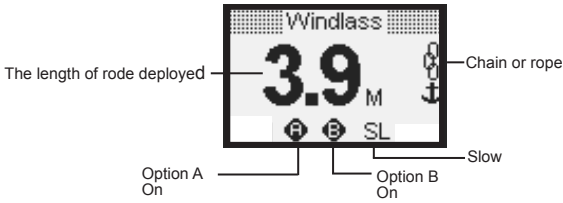

4.2 AA730 BUTTONS

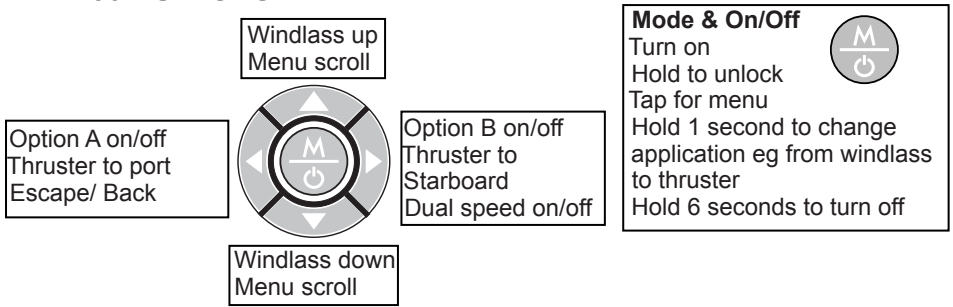

4.2.1 TO CONNECT THE CONSOLE FOR USE

- Unscrew the sealing cap on the deck socket.
- Fit the plug into the socket ensuring the pins are aligned correctly.
- Turn clockwise to lock.
- Switch on the power supply .
- Use the system as set up.
- When finished unscrew the plug from the socket.
- Replace the sealing cap and return the console to the cradle.

4.2.2 TO TURN THE AUTO ANCHOR ON



- Power up the AA703 base station.
- Press the Mode button to turn the remote console on. The screen will be locked and will display the last mode operated.

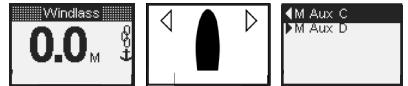

4.2.3 TO TURN THE AUTO ANCHOR OFF



OR



- In the start screen press the Mode button to display the menu.
- Scroll to Off.
- Select Off.



Note: The AA730 remote console automatically turns off after 5 minutes without use.

4.2.4 LOCK



Hold the Mode button for 2 seconds to unlock. The AA730 automatically turns off and resets the lock after 5 minutes without use.

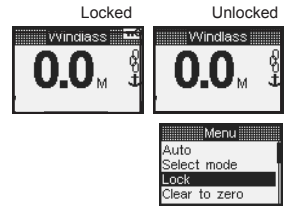

To reset the lock manually:



Press the Mode button to display the menu.



Select Lock. The screen will return to the current mode with the lock on.

4.2.5 CHANGING MODES



Cycle through the modes by pressing the Mode button for 1 second at a time

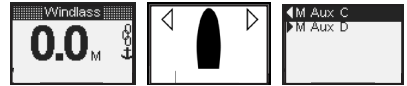

OR



Press and release the Mode button to access the menu. Select the Mode.

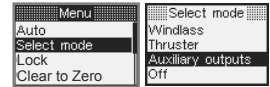

4.3 SET UP AND TESTING

Before use the AutoAnchor must be correctly set up for the equipment it is to control and then tested in a safe environment. For example, the AutoAnchor will not count correctly if the windlass selection is wrong or the windlass is not standard (eg it is installed with a different chainwheel or motor).

4.4 USER PRECAUTIONS

It is the owner's sole responsibility to ensure the AutoAnchor is installed, used and maintained in a manner that will not cause accidents, personal injury or property damage. When using the AutoAnchor the operator must follow safe boating practices for all equipment use.

- all equipment controlled by the AutoAnchor must be installed and used strictly according to the original equipment manufacturer's instructions;
- only persons who are fully aware of the correct use of the thruster, windlass, auxiliary or optional equipment should be allowed to use the AutoAnchor to control this equipment;
- the user must personally control and supervise all anchoring, docking and other equipment operations;
- the user must have a clear view of all equipment when operated using the AutoAnchor;
- the user must know the location of the main breaker or battery switch to disconnect the windlass, thruster or auxiliary equipment from all power sources in the event of an emergency;
- the power supply to all equipment must be turned off when it is not in use;
- there must be an alternative method available to operate all equipment to be operated by the AutoAnchor, including the windlass, thruster, auxiliary and optional equipment.

The AutoAnchor manufacturer and supplier accept no liability for personal injury or property damage resulting from failure to follow the installation and operating instructions or the use of the AutoAnchor in a way that may cause accidents or damage or that may violate the law.

4.5 WINDLASS OPERATION WITH THE AA730

WHEN CONTROLLING A WINDLASS

- maintain a clear view of the windlass, rode and/or anchor, plus any optional or auxiliary anchoring equipment during windlass operation;
- always ensure the anchor is fully docked and secured before moving the boat.

4.5.1 PLUG & PLAY SENSOR TUNING

Required for all sensors other than a motor driven reed sensor. This screen automatically displays on first use or if Factory Defaults are loaded, the sensor is reset or there has been a loss of sensor signal.

Installation and set up must be complete and the anchor must be docked before starting this process.

Clear the AutoAnchor to zero if necessary. See page 33.

Deploy the anchor using the AutoAnchor. Initially the status bar will display “**Sensor tuning**”. Continue deployment until this message changes to “**Tuning done**”. **This must be done in one continuous operation without taking your finger off the button until the “Tuning done” message displays. This could take up to 10 turns of the windlass.** Retrieve the anchor to the docked position and clear to zero if needed.



Note: If you do need to take your finger off the button, start the process again.

Rope/Chain System: The default rode set up is chain only. If rope and chain rode is selected without the correct sensor and magnet set up a “Sensor installation not compatible with rope and chain setting” message will display. Check the installation and rode set up and reset the sensor to restart the tuning process.



4.5.2 AUTOMATIC AND MANUAL WINDLASS OPERATION

Keep your finger on the button to deploy the anchor manually or use the automatic function for hands free anchor deployment and retrieval. See the instructions for both options below.

Note: The AA730 remote console automatically turns off after 5 minutes without use.



For an accurate reading always ensure the AA730 display reads 0.0 before deploying the anchor. See Clear to Zero on page 33.



Counting continues if the AA730 remote console is turned off and if the windlass is operated by another control eg foot switches.

4.5.3 MANUAL WINDLASS OPERATION

Deploy and Retrieve the Anchor Using Manual Operation

-  Turn the AA730 on.
-  Clear the safety lock.
-  Press and hold the up or down button to deploy or retrieve the anchor. Releasing the button stops the windlass operation.
Ensure the anchor is fully docked and secured before moving the boat.

DOCKING ALARM: During retrieval the windlass will stop and the AA730 beeps to warn the operator the anchor is at the preset docking distance. Press and hold the button to continue retrieval. If the system has been set up for dual speed. It will change to slow at this point. **Extra care must be taken at this stage of retrieval.**

4.5.4 AUTOMATIC WINDLASS OPERATION



WARNING: There is an inherent risk when using any automatic function on a boat. If you choose to use the AA730 automatic functions, you must still control and supervise all windlass and anchoring operation.

Use the Automatic Function to:

- Preset the length of rode for deployment;
- Have hands-free operation of the windlass;
- Retrieve the anchor automatically to the preset docking distance.

Note: For rope/chain counting, if the sensor or load sensing wires are not installed correctly the automatic function **will not operate**. An Installation warning message will display on the screen. The windlass can still be operated using manual operation but the AutoAnchor will not count accurately.







4.5.4.1 Safety Override

Press any button on the AA730 to stop the windlass during automatic release or retrieval. In an emergency shut off the power to the windlass using the isolating/breaker switch.

4.5.4.2 Enable Automatic Operation

A “rode to be released” value must be entered to use automatic operation.



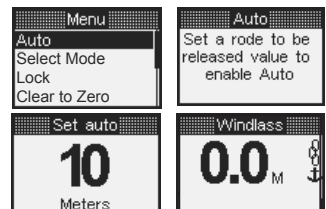

4.5.4.3 To Set A Rode to be Released Value

-  Turn the AA730 on.
-  Clear the safety lock.
-  Press the Mode button to enter the menu.
-  Press the Mode button twice to enter Set auto.
-  Scroll up or down to the value.
-  Save and return to start screen.





To disable automatic operation: Set the rode to be released value to Off.

4.5.4.4 Deploy the Anchor Using Automatic Operation

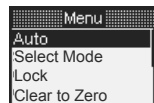
-  Turn the AA730 on.
-  Clear the safety lock.
-  Press the Mode button to enter the Menu.
-  Press the Mode button again to select Auto. The screen displays the current length for Auto release. If this setting is correct, press and release the down button to deploy the anchor.









To Change the Setting:

-  Press the Mode button again to select Set auto.
-  Scroll to the value.
-  Save and return to Auto.



The windlass will stop and the AA730 will beep when the preset length of rode has been released. The screen will display "Target reached".

4.5.4.5 Retrieve the Anchor Using Automatic Operation

-  Turn the AA730 on.
-  Clear the safety lock.
-  Press the Mode button to enter the Menu.
-  Press the Mode Button again to select Auto.
-  Press and release the Up button to retrieve the anchor. The windlass will stop and the AA730 will beep when the docking distance is reached. The screen will display Docking distance. If the system is set up for dual speed, it will change to slow speed at this point.
-  Press and hold the Up button to complete retrieval of the anchor. The AA730 will beep during this process.

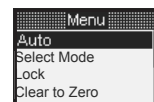

Ensure the anchor is fully docked and secured before moving the boat.

4.6 USING DUAL SPEED

You must have a windlass with a dual speed motor to use this feature. **Default Speed is slow.**

 Use the right arrow to toggle between fast and slow speed. The current speed is displayed on the screen SL or FS.

If using Auto Mode select fast speed prior to selecting Auto.

The windlass automatically changes to slow speed when the docking distance is reached.

4.7 TO USE WINDLASS OPTION A AND OPTION B

- ◀ Use the Left arrow to turn Option A on and off.
- ▶ Use the Right arrow to turn Option B on and off.

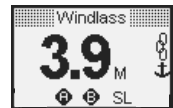





Note: If Auto wash is set it will turn on automatically during retrieval if any windlass control is used. Control could be via the AA730 and also foot switches, toggle switches or another AutoAnchor unit.

4.8 OTHER WINDLASS OPERATION SETTINGS

4.8.1 TO CLEAR TO ZERO

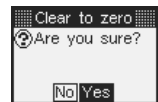
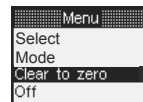

The AA730 must be turned on.

-  Press to access the Menu.
- ▼ Scroll to Clear to Zero.
-  Select Clear to zero.
- ◀▶ Select No/Yes.
-  **Yes** - return to start screen.
-  **No** - return to the menu, then press ◀ again to return to the start screen.



4.8.2 TO CHECK LOGS



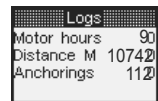
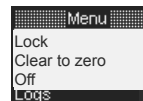

The AA730 must be turned on.

-  Press to access the Menu.
 - ▼ Scroll to Logs.
 -  Select Logs.
 - ◀ Return to the menu.
 - ◀ Exit and return to start screen.
- Logs can be cleared if base station is reset.



4.8.3 TO RESET SENSOR

The AA730 must be turned on.

-  Press to access the Menu.
 -  Select Reset sensor.
 - ◀▶ Select No/Yes.
 -  **Yes** - return to start screen.
 -  **No** - return to the menu, then press ◀ again to return to the start screen.
- Deploy the anchor to tune the sensor. See page 30.

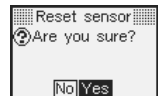
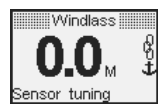
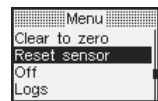

4.9 THRUSTER OPERATION WITH THE AA730

The AA730 can control a single bow thruster or a bow and stern thruster together.







4.9.1 USER PRECAUTIONS

Note: The AA730 remote console automatically turns off after 5 minutes without use. There must be an alternative means of controlling the thruster installed on the boat.

Only persons who are fully aware of the requirements for safe operation of the thruster should be allowed to use the AA730 to operate this equipment. The owner of the boat must take responsibility for ensuring the thruster is used according to the manufacturer's instructions and with the appropriate safety precautions.

The thruster must not be operated close to swimmers, the powerful suction of water could cause serious injury. Never run the thruster out of the water as this can seriously damage the motor. Running a thruster without resistance from the propeller can also cause serious damage to the motor. If the thruster stops giving thrust while the motor is running, turn it off immediately. Always turn off the power to the thruster when it is not in use.

4.9.2 TO ACCESS THE THRUSTER

-  Turn the AutoAnchor on.
-  Clear the safety lock.
-  Cycle through the modes by pressing the Mode button for 1 second at a time
- OR**
-  Access the Menu.
-  Select "Select Mode".
-  Scroll to Thruster.
-  Select Thruster.

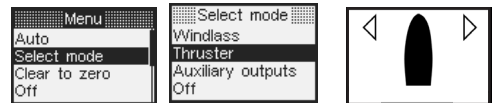
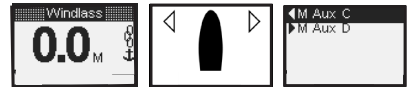

4.9.3 THRUSTER SYSTEM LOCKS



AA730 System locked.
Hold Mode button to clear.

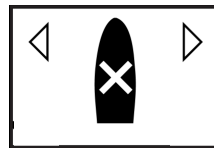

Local lock on. No access from AA730.
Thruster operated by another controller.

4.9.4 SINGLE BOW THRUSTER OPERATION

-  Use the left and right arrow buttons to control the thruster operation.
Left to port and and right to starboard.

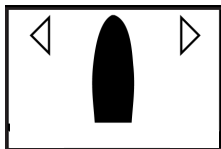

Bow thruster selected.
System powered up and idle.

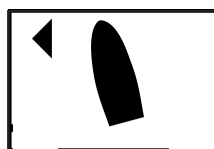

Thrust to port.

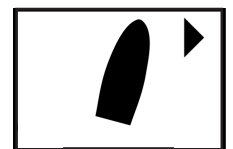

Thrust to starboard.

4.9.5 COMBINED BOW AND STERN THRUSTER OPERATION

- △ If there is a bow and a stern thruster fitted, use the up button to toggle between the bow thruster and the combined bow and stern thruster.
- ▽ Use the down button to toggle between the stern thruster and the combined bow and stern thruster.
- ◁▷ Use the left and right arrow buttons to control the thruster operation to port and starboard.

4.9.5.1 Dual Thruster Operation

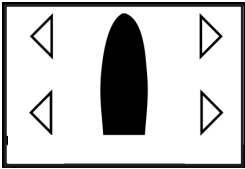

Bow and stern thrusters selected. System powered up and idle.

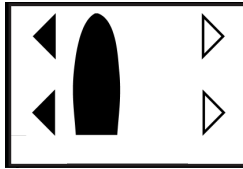

Bow and stern thrusters to port.

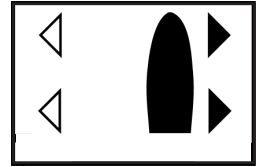

Bow and stern thrusters to starboard.

4.9.5.2 Bow Thruster Operation

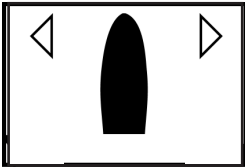

Bow thruster selected. System powered up and idle.

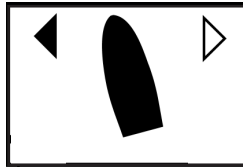

Bow thrusting to port.

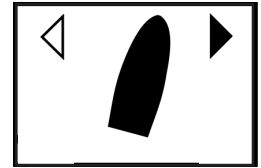

Bow thrusting to starboard.

4.9.5.3 Stern Thruster Operation

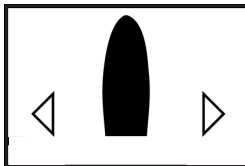

Stern thruster selected. System powered up and idle.

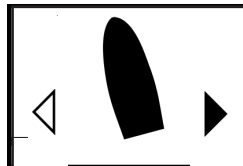

Stern thrusting to starboard.

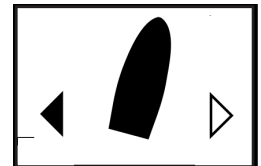

Stern thrusting to port.

4.9.5.4 Pivot (360° Turn) Operation

Pivot mode can be selected from any thruster operation mode, by pressing the Up button for more than 1 second. For example:

Bow thruster selected. System powered up and idle.

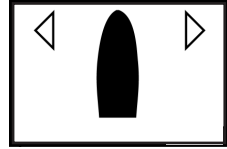

△ Hold the Up button for more than 1 second to change to Pivot Mode.



◀▶ Use the left or right buttons to turn the boat clockwise or anticlockwise.

▶  Clockwise.

◀  Anticlockwise.

△▽ To exit pivot mode and return to single thruster operation press the up or down button.

△ Press the up button to return to bow thruster operation.

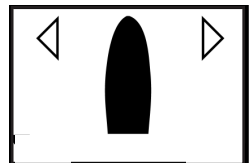

▽ Press the down button to return to stern thruster operation.

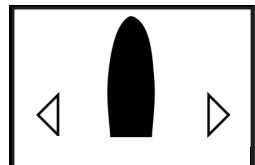

4.10 AUXILIARY EQUIPMENT OPERATION WITH THE AA730



The AA730 can control other equipment on the boat such as pumps, davits or cleats using the auxiliary outputs.

4.10.1 USER PRECAUTIONS





Only persons who are fully aware of the requirements for safe operation of the auxiliary equipment should be allowed to use the AA730 to operate this equipment. The owner of the boat must take responsibility for ensuring the equipment is used according to the manufacturer's instructions and with the appropriate safety precautions.

Note: The AA730 remote console automatically turns off after 5 minutes without use.

4.10.2 TO ACCESS THE AUXILIARY MODE

-  Turn the AA730 on.
-  Clear the safety lock.
Depending on the system set up.
-  Cycle through the modes by pressing the button for 1 second at a time.

OR

-  Tap to access the Menu.
-  Scroll to "Select Mode".
-  Select "Select Mode".
-  Scroll to Auxiliary outputs.
-  Select Auxiliary outputs.

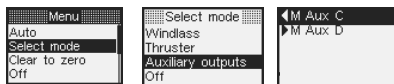
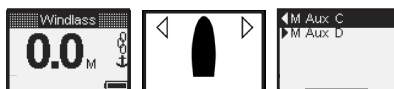

On the console use the key shown on the screen to operate the Auxiliary output. The Auxiliary output will be highlighted on the screen when it is active.

M = Momentary
T = Toggle

Auxiliary Key References

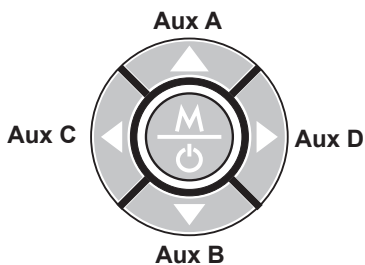

PART 5 MAINTENANCE

The AutoAnchor does not contain any user servicable parts.

User maintenance is limited to:

- Checking all cables and connections for signs of wear or damage and replacing them as necessary.
- Checking the sensor head is not worn and has not moved out of alignment with the magnet and replacing the sensor if necessary. **After any sensor repairs or changes to sensor installation reset the sensor. See page 30.**
- Checking the magnet is not worn or corroded and replacing the magnet if necessary.

Note: Do not use chemical or abrasive materials to clean the console unit. If it is dirty wipe it with a clean damp cloth. Avoid wiping the display screen with a dry cloth as this could scratch the screen.

PART 6 TROUBLESHOOTING

Messages are displayed on the AA730 console screen to assist with operation and troubleshooting. These messages are designed to assist the user. They may be **information messages**, for example that the console is locked, or the sensor is tuning. They may also be **diagnostic messages**, for example, that the sensor installation is not compatible or the power supply is wired incorrectly.

Many of the messages are self explanatory. Some will require further diagnostics. See the Troubleshooting Messages, the Diagnostics Table and the Internal Voltmeter/Test Tool information on the following pages.

Please Note: The messages are designed to help find an installation problem. They are triggered by external wiring, installation or set up issues which need fixing. **They are not caused by a fault with the AutoAnchor.**

| TROUBLESHOOTING MESSAGES | POSSIBLE CAUSE/ACTION |
|--|---|
| <p>1. Auto mode disabled</p> <p><i>Note: Unless the fault is in the solenoid wiring the AA730 will operate the windlass in manual mode when this message is displayed.</i></p> | <p>Auto mode is disabled when:</p> <ol style="list-style-type: none"> 1. No sensor pulses are detected. See message 6 below. 2. The sensor installation is not compatible with rope and chain settings. See message 7 below. 3. The load sensing wires are not connected for rope/chain counting. See the rope/chain wiring diagram and message 7 below. 4. A solenoid wire is disconnected. See message 9 below. 5. No rode to be released value has been entered. See page 31. 6. Total rode set to OFF. See page 23. |
| <p>2. Battery voltage too low to operate windlass.</p> <p><i>The voltage displays on the status bar.</i></p> | <ol style="list-style-type: none"> 1. If the battery is fully charged, check the wiring for bad connections. 2. Check the cable meets the specifications. If the cable is the wrong size there may be voltage drop between the battery and the AutoAnchor. See cable sizes on page 14. <p>Go to the Diagnostics in the Set up menu to view the battery information. See the table on page 14 and 42.</p> |

| TROUBLESHOOTING MESSAGES Cont'd | POSSIBLE CAUSE/ACTION |
|--|--|
| 3. Installation warning | Appears when switching on the AutoAnchor. Go to Diagnostics for more information. |
| 4. Motor externally controlled. | <ol style="list-style-type: none"> 1. Another control is being used for the windlass. 2. Solenoid common ground is not connected or swapped with an up or down terminal. 3. Large voltage potential difference between AA730 Ground and Solenoid common ground. |
| 5. Power supply wired incorrectly. | The wiring diagram has not been followed. Power is backfeeding to the AutoAnchor from a supply outside the control circuit. Refer to wiring diagram. Common example of incorrect wiring is AA730 and deck switches powered from separate sources. |
| <p>6. Sensor: No sensor pulses detected.</p> <p><i>Note: The AA730 will continue to operate the windlass up and down in manual mode when this message is displayed. It will not count.</i></p> | <ol style="list-style-type: none"> 1. Use manual operation to check the windlass speed is more than the minimum operating speed of 5 metres per minute. Windlass speed is displayed on the status bar. 2. Check the correct windlass set up and sensor has been selected. See pages 23-27. 3. Check the magnet and sensor installation. 4. Check the magnet and sensor are not damaged (eg rusted magnet). 5. Check the gap between the magnet and sensor is correct for your set up. 6. If using a rope/chain system check that the sensor installation is compatible with a rope/chain set up. See message 7 below. 7. Go to Diagnostics in the Set Up Menu to view sensor voltages. See the tables on pages 41-42. |
| <p>7. Sensor: Sensor installation not compatible with rope and chain settings.</p> <p><i>Note: The AA730 will continue to operate the windlass up and down in manual mode when this message is displayed. The count will not be accurate.</i></p> | <p>APPLIES TO ROPE/CHAIN SYSTEMS ONLY</p> <ol style="list-style-type: none"> 1. Check the correct windlass set up has been selected. See page 23. 2. Check magnet and sensor installation is correct. The grey AA sensor must be installed for rope/chain counting. The magnet must be installed in the top of the chainwheel and the sensor must be fitted as per figure 5 on page 8. 3. Check that the load sensing wires are connected. Refer to the rope/chain wiring diagram. 4. Go to Diagnostics in the Set Up Menu to view sensor signal readouts. See tables on page 41-42. |
| 8. Sensor: Sensor tuning and tuning done | <ol style="list-style-type: none"> 1. The plug and play sensor detector is operating. Deploy the rode through the windlass until the message changes to "Tuning done" then dock the anchor. See page 30. 2. If the "sensor tuning" message does not change to "tuning done" after 10 turns of the windlass, check the sensor installation is correct. |
| 9. Solenoid is disconnected, shorted or stuck on. | <ol style="list-style-type: none"> 1. Use another control to check the solenoid is operating the windlass. 2. Go to Diagnostics in the Setup menu to view the solenoid wiring readouts. See the table on page 42. 3. Check solenoid wiring for open circuit or short circuit. |

| OTHER TROUBLESHOOTING | POSSIBLE CAUSE/ACTION |
|--|---|
| <p>1. AutoAnchor counts when the windlass is not turning or counts erratically displaying a large number. The screen may display Sensor unstable and the unit may beep when turned off or locked.</p> | <p>1. Uncontrolled anchor rode could be running through the windlass or there may be some external interference. 2. The sensor may be damaged. The sensor cable is not the specified type or the connection may be faulty. 3. Check the sensor wiring. If the AA sensor plug is not used the wires must be soldered. All wires must be connected (including the drain) and shielded cable must be used.</p> |
| <p>3. AutoAnchor counts but does not operate the windlass</p> | <p>Total length of rode has been set to off. AutoAnchor then operates as a counter only. See page 26.</p> |
| <p>4. The count pauses during retrieval. <i>This applies to rope/chain rode only.</i></p> | <p>If the sensor indicator (arrow) is still pulsing, this is not a fault. The rode is changing from rope to chain.</p> |
| <p>5. The count stays on zero when rode is deployed and counts out when rode is retrieved.</p> | <p>The unit is not receiving correct direction information. Solenoid up and down wires are swapped.</p> |
| <p>6. Windlass deploys when the Up button is pressed and retrieves when the Down button is pressed.</p> | <p>1. The motor or solenoid wiring is reversed. Change the wiring and check the direction of windlass rotation. If the brown and white wires are connected, also check that they are correct after you have changed the wiring. 2. Buttons are swapped in the windlass menu. See page 27.</p> |
| <p>7. Windlass does not stop exactly at the preset point.</p> | <p>Stopping is accurate to +1 chainwheel revolution. The chainwheel will run on slightly with momentum.</p> |
| <p>8. Windlass stops before the length of rode specified is deployed.</p> | <p>Using the Automatic function the rode release stops 10ft (3m) short of the Total Length of Rode on Board setting.</p> |

AFTER ANY SENSOR REPAIRS OR CHANGES:

DOCK THE ANCHOR AND RESET THE SENSOR. SEE PAGE 30.

FOR ADDITIONAL TROUBLESHOOTING:

Contact AutoAnchor support on:

www.autoanchor.co.nz/autoanchor-installation-help.php Fill in the information form.

Email: support@autoanchor.co.nz or Telephone: +64 9 360 0300

PART 7 TECHNICIAN DIAGNOSTIC INFORMATION

Diagnostic messages help find an installation problem. The diagnostic messages are all caused by external wiring, set up or installation issues which need fixing. They are not caused by a fault with the AutoAnchor.

INTERNAL VOLTMETER/TEST TOOL: This tool displays the voltages and status of sensor, battery and load wires. The information is required by the AutoAnchor support team for effective technical assistance.

Contact AutoAnchor support on:

www.autoanchor.co.nz/autoanchor-installation-help Fill in the information form.



or

Email: support@autoanchor.co.nz or Telephone: +64 9 360 0300.

Access the information from the Set up menu or from the installation warning screen.

The AA730 must be turned off to access the Set up menu.

Hold  together to display the Set up menu.

Use  to scroll through the menus and  to select Diagnostics.

Press  again for extended diagnostic information and test tools.

To update the recorded signal levels rotate the windlass 2 or more turns
Press  buttons or freewheel the windlass to rotate.

Check the windlass is safe and clear before using this function.

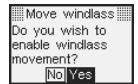
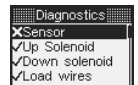

Sensor Information

| Sensor | Source Icon Signal Voltage (V) Signal (mV) | <input checked="" type="checkbox"/> Correct Parameters |
|---|---|---|
| AA Grey Sensor Chain Only Set Up <i>Bottom Fit Magnet</i> <i>Polarity not relevant</i> | | Signal A - (Red sensor wire from the console) is sensor power supply. Voltage must be between 4.6V and 4.9V. Signal B - Reading depends on gap and magnet polarity. Range 0.5V - 4.6V. Minimum working signal 0.5V. Signal C - If Signal B is less than 0.5V then Signal C will take over and operate down to 100mV for an all chain set up. |
| AA Grey Sensor Rope/Chain Set Up <i>Top Fit Magnet</i> <i>Polarity not relevant</i> | | Signal A - (Red sensor wire from the console) is sensor power supply. Signal B - Reading is not relevant. Signal C - Minimum value is 100 mV when reading the chain pulses. |
| AA Black Sensor Chain Only Set Up <i>Bottom Fit Magnet</i> <i>South pole must face sensor</i> | | Signal A - (Red sensor wire from the console) moves between 2.6V and 4.6V. Minimum working signal 0.5V. Signal B - Reading is not relevant Signal C - Reading is not relevant. |
| Reed Switch Chain Only Set Up <i>Bottom Fit Magnet</i> <i>Polarity not relevant</i> | | Signal A - (Red sensor wire from the console) is not used. Black sensor wire (from the console) is connected to the reed switch. Signal B - Range is 0.0V to 5V. Signal C - Reading is not relevant. |
| NPN Proximity Sensor Chain Only Set Up | | Signal A - (Red sensor wire from the console) is the proximity sensor's power supply. Signal B - Range 2.5V - 4.6V. Minimum working signal 0.5V Signal C - Reading is not relevant. |

Sensor Installation Diagnostic Messages

These messages appear when the AA730 is turned on. Go to the extended diagnostics for more information. After fixing the sensor installation retune the sensor. See page 30.

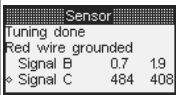
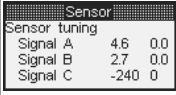
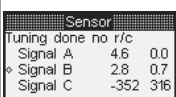
| | | |
|--|---|---|
| Red sensor wire grounded |  | <p>The Red sensor wire is overloaded below 2.5 volts Disconnect the plugs one at a time to locate the short or excessive load. If no short is found, the sensor may be damaged. Try a new sensor. <i>Windlass will operate but not count.</i></p> |
| No Sensor pulses |  | <p>Electrical connections are OK (voltages are correct) but no sensor pulses are being received by the console and it is not counting. Rotate the windlass to check for signal voltage. If there is still no signal either the magnet or the sensor needs replacing. Check the magnet is strong and not rusted and check the sensor for physical damage.</p> |
| Sensor installation not compatible with rope and chain settings. |  | <p>A rope/chain rode has been selected but the installation is not compatible with this selection. The system is tuned to the Signal B sensor input (all chain) instead of Signal C sensor input (rope/chain). Possible causes: Magnet is installed on the bottom of chainwheel instead of the top. The sensor is not the grey AA sensor. The windlass has been operated with no chain so the tuning is incorrect.</p> |

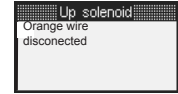
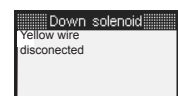
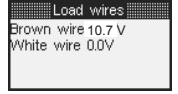
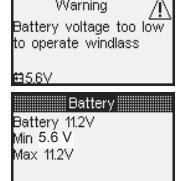
| Other Diagnostic Messages | Possible Causes and Solutions | |
|---------------------------|---|---|
| Up Solenoid |  | <p>Check the solenoid wires are properly connected. Solenoid common ground is not connected or swapped with an up or down terminal. The load connected to the solenoid wires is insufficient. Check that each solenoid wire has a load of more than 10mA (12V DC) or 20mA (24V DC). The idle voltage is greater than 2.0V - this can occur when connecting to a solid state or low current drive windlass control eg PLC or AC VFD. A dummy resistor load Part #9515 may be required to fix this.</p> |
| Down Solenoid |  | |
| Load wires |  | <p>These wires are used for combination rope and chain rodes. They are not required for chain only use. When correctly connected to the motor terminal both wires show nearly zero volts at idle. Under load they show motor ground and supply terminal voltages.</p> |
| Battery |  | <p>The voltage at the time of failure is recorded on the status bar. This page records the voltage drop when the motor is started. In this example the supply voltage to the AA730 fell below 6V for a short period. The power supply wiring has high resistance or is too thin for the distance of the run or the ground wire is disconnected.</p> |

Appendix 1

1.1 Chain per Revolution for Chain Only Windlasses

Enter the chain per revolution for the windlass.

If your windlass is not listed below, refer to the Operation Manual for instructions to calculate the chain per revolution.

LEWMAR CHAIN ONLY WINDLASSES

| Chainwheel | Chain Size | Chain per Revolution |
|------------|------------|----------------------------|
| 603 | 1/4" 7 mm | 205mm (8.07 inches) |
| 604 | 5/16" 8 mm | 290mm (11.42 inches) |
| 001 | 5/16" 8mm | 330mm (12.99 inches) |
| 002 | 5/16" 8mm | 310mm (12.20 inches) |
| 002 | 3/8" 9.5mm | 10 mm 330mm (12.99 inches) |
| 003 | 3/8" 9.5mm | 10 mm 295mm (11.61 inches) |

LOFRANS CHAIN ONLY WINDLASSES

| Windlass Model | Chainwheel Reference | Chain Size | Chain per Revolution |
|--------------------|----------------------|------------|----------------------|
| Project 1000-1000W | 916b | 5/16" | 272 mm (10.7 inches) |
| Project 1500-1200W | 989a 80102 | 5/16" | 307 mm (12.1 inches) |
| Project 1500-1200W | 989b 10103 | 3/8" | 295 mm (11.6 inches) |
| Project 1500-1500W | 989a 80102 | 5/16" | 307 mm (12.1 inches) |
| Project 1500-1500W | 989b10103 | 3/8" | 295 mm (11.6 inches) |

MAXWELL CHAIN ONLY WINDLASSES

| Windlass Model | Chainwheel Reference | Chain Size | Chain per Revolution |
|----------------|----------------------|--------------|-----------------------|
| Freedom 500 | P100030 | 1/4"(7mm) | 295 mm (11.6 inches) |
| Freedom 500M | P100031 | 6 mm | 292 mm (11.5 inches) |
| Freedom 800 | P100033 | 5/16" | 256 mm (10.1 inches) |
| Freedom 800M | P100034 | 8 mm | 290 mm (11.4 inches) |
| HRC 6 or HRC 8 | 6050/1 | 6 mm | 295 mm (11.6 inches) |
| HRC 6 or HRC 8 | 6062/3 | 1/4"(7 mm) | 300 mm (11.8 inches) |
| HRC 8 | 6074/5 | 8 mm | 290 mm (11.4 inches) |
| HRC 8 | 6086/7 | 5/16" | 310 mm (12.2 inches) |
| Liberty | 5220/P101525 | 3/8" (10 mm) | 330 mm (13.0 inches) |
| Liberty | 5346/P101542 | 5/16" | 360 mm (14.2 inches) |
| Liberty | 5443/P101547 | 8 mm | 340 mm (13.4 inches) |
| RC10 | P103309 | 3/8" (10mm) | 322 mm (13.01 inches) |

MUIR CHAIN ONLY WINDLASSES

| Windlass Model | Chainwheel Reference | Chain Size | Chain per Revolution |
|---------------------------------|----------------------|-----------------|-----------------------|
| Atlantic 600 | 116 | 1/4"(6 mm) | 248 mm (9.76 inches) |
| Atlantic 600 | 117 | 1/4" | 210 mm (8.27 inches) |
| Atlantic 850-1250 | 66 | 1/4" (6 mm) | 316 mm (12.44 inches) |
| Atlantic 850-1250 & 2200 | 80 | 5/16"(8 mm) | 328 mm (12.91 inches) |
| Atlantic 850-1250 & 2200 | 99 | 3/8"(10 mm) | 322 mm (12.68 inches) |
| Atlantic 850-1250 & 2200 | 112 | 3/8" (10 mm) | 310 mm (12.2 inches) |
| Atlantic 850-1250 | 120 | 5/16"(8 mm) | 330 mm (12.99 inches) |
| Atlantic 2200, 2500, 3500, 4000 | 121 | 5/16"(8 mm) | 377 mm (14.84 inches) |
| Atlantic 2200, 2500, 3500, 4000 | 130 | 13 mm | 400 mm (15.75 inches) |
| Atlantic 2500, 3500, 4000 | 57 | 5/16" | 405 mm (15.94 inches) |
| Atlantic 2500, 3500, 4000 | 60 | 3/8" HT | 368 mm (14.49 inches) |
| Atlantic 2500, 3500, 4000 | 61 | 3/8" BBB | 380 mm (14.96 inches) |
| Atlantic 2500, 3500, 4000 | 114 | 1/2" DIN 766 | 420 mm (16.54 inches) |
| Atlantic 2500, 3500, 4000 | 119 | 3/8"(10 mm) | 405 mm (15.94 inches) |
| Atlantic 2500, 3500, 4000 | 130 | 13 mm | 400 mm (15.75 inches) |
| Atlantic 2500, 3500, 4000 | 131 | 7/16" (12.5 mm) | 420mm (16.54 inches) |

1.2 Pre-set Windlass Profile List for Rope & Chain Windlasses

Find the windlass model.

Check the chainwheel reference.

Check the chain size.

Check the rope size.

Select the AutoAnchor reference number.

If your windlass is not on the list, you need to calculate the length of chain and rope that is released during one complete revolution of the chainwheel. See Operation Manual for instructions.

LEWMAR ROPE & CHAIN WINDLASSES

| Windlass | Motor | Volts | Chainwheel Reference | Chain Size | Rope Size 3 Strand | AutoAnchor Reference |
|-----------------------|-------|-------|----------------------|------------|--------------------|----------------------|
| Lewmar Sprint 600 | 250W | | 12 603 | 1/4" 7mm | 1/2" 12mm | 128 |
| Lewmar Sprint 1000 | 400W | | 12 604 | 5/16" 8mm | 9/16" 14mm | 129 |
| Lewmar V2 | 700W | | 12 001 | 5/16" 8 mm | 9/16" 14mm | 123 |
| Lewmar V2 | 700W | | 12 001 | 5/16" 8mm | 5/8" 16mm | 122 |
| Lewmar V2 | 700W | | 12 002 | 3/8" 9.5mm | 9/16" 14mm | 119 |
| Lewmar V2 | 700W | | 12 002 | 3/8" 9.5mm | 5/8" 16mm | 118 |
| Lewmar V2 | 700W | | 12 002 | 5/16" 8mm | 9/16" 14mm | 114 |
| Lewmar V2 | 700W | | 12 002 | 5/16" 8mm | 5/8" 16mm | 113 |
| Lewmar V2 | 1000W | | 12 003 | 3/8" 9.5mm | 5/8" 16mm | 120 |
| Lewmar V3 | 1000W | | 12 002 | 5/16" 8mm | 5/8" 16mm | 116 |
| Lewmar V3 | 1000W | | 12 001 | 5/16" 8 mm | 5/8" 16 mm | 126 |
| Lewmar V3 | 1000W | | 12 001 | 5/16" 8 mm | 9/16" 14mm | 127 |
| Lewmar V3 | 1000W | | 12 002 | 3/8" 9.5mm | 9/16" 14mm | 124 |
| Lewmar V3 | 1000W | | 12 002 | 5/16" 8 mm | 9/16" 14mm | 117 |
| Lewmar V700 | 320W | | 12 765 + 670 | 1/4" 7mm | 1/2" 12mm | 130 |
| Lewmar V700 | 320W | | 12 670 | 1/4" 6mm | 1/2" 12mm | 130 |
| Lewmar Pro-Series 700 | 500W | | 12 762 | 1/4" 7mm | 5/8" 16mm | 131 |

LOFRANS ROPE & CHAIN WINDLASSES

| Windlass Model | Chainwheel | Chain Size | Rope Size | AutoAnchor Reference |
|--------------------|------------|--------------|------------------------|----------------------|
| Dorado | | 7mm | 14mm | 65 |
| Dorado | | 7mm | 12 mm | 66 |
| Project 1000-1000W | 916b | 5/16" | 5/8" (16mm) 3 strand | 61 |
| Project 1000-1000W | 916b | 5/16" | 5/8" (16 mm) 8 plait | 62 |
| Project 1000-1000W | 916b | 5/16" | 9/16" (14 mm) 3 strand | 63 |
| Project 1000-1000W | 916b | 5/16" | 9/16" (14 mm) 8 plait | 64 |
| Project 1500-1200W | 989a 80102 | 5/16" | 5/8" (16 mm) 3 strand | 55 |
| Project 1500-1200W | 989a 80102 | 5/16" | 5/8" (16 mm) 8 plait | 56 |
| Project 1500-1200W | 989b 10103 | 3/8" (10 mm) | 3/4" (20 mm) 3 strand | 57 |
| Project 1500-1200W | 989b 10103 | 3/8" (10 mm) | 3/4" (20 mm) 8 plait | 58 |
| Project 1500-1200W | 989b 10103 | 3/8" (10 mm) | 5/8" (16 mm) 3 strand | 59 |
| Project 1500-1200W | 989b 10103 | 3/8" (10 mm) | 5/8" (16 mm) 8 plait | 60 |
| Project 1500-1500W | 989a 80102 | 5/16" | 5/8" (16 mm) 3 strand | 49 |
| Project 1500-1500W | 989a 80102 | 5/16" | 5/8" (16 mm) 8 plait | 50 |
| Project 1500-1500W | 989b10103 | 3/8" (10 mm) | 5/8" (16 mm) 3 strand | 47 |
| Project 1500-1500W | 989b10103 | 3/8" (10 mm) | 5/8" (16 mm) 8 plait | 48 |
| Project 1500-1500W | 989b10103 | 3/8" (10 mm) | 3/4" (20 mm) 3 strand | 46 |
| Project 1500-1500W | 989b10103 | 3/8" (10 mm) | 3/4" (20 mm) 8 plait | 45 |

MAXWELL ROPE & CHAIN WINDLASSES





| Windlass Model | Chainwheel Reference | Chain Size | Rope Size | AutoAnchor Reference |
|---------------------|----------------------|--------------|-----------------------------------|----------------------|
| Freedom 500 | P100030 | ¼" (7 mm) | ½" (12 mm) 3 strand | 35 |
| Freedom 500 | P100030 | ¼" (7 mm) | ½" (12 mm) 8 plait | 34 |
| Freedom 500-1000W | P100030 | ¼" (7 mm) | ½" (12 mm) 3 strand | 21 |
| Freedom 500M | P100031 | 6 mm | ½" (12 mm) 3 strand | 2 |
| Freedom 500M | P100031 | 6 mm | ½" (12 mm) 8 plait | 33 |
| Freedom 500M-1000W | P100031 | 6 mm | ½" (12 mm) 3 strand | 22 |
| Freedom 800 | P100033 | 5/16" | 5/8" (16 mm) 3 strand | 40 |
| Freedom 800 | P100033 | 5/16" | 5/8" (16 mm) 8 plait | 39 |
| Freedom 800 | P100033 | 5/16" | ½" (12 mm) 3 strand | 36 |
| Freedom 800 | P100033 | 5/16" | ½" (12 mm) 8 plait | 37 |
| Freedom 800 | P100033 | 5/16" | 9/16" (14 mm) 3 strand | 38 |
| Freedom 800M | P100034 | 8 mm | 9/16" (14 mm) 3 strand | 1 |
| Freedom 800M | P100034 | 8 mm | ½" (12 mm) 3 strand | 41 |
| Freedom 800M | P100034 | 8 mm | ½" (12 mm) 8 plait | 42 |
| HRC 6 | 6050/1 | 6 mm | ½" (12 mm) 3 strand or 8 plait | 23 |
| HRC 6 | 6062/3 | ¼" (7mm) | ½" (12 mm) 8 strand or 8 plait | 24 |
| HRC 8 | 6050/1 | 6 mm | ½" (12 mm) 3 strand or 8 plait | 25 |
| HRC 8 | 6062/3 | ¼" (7 mm) | ½" (12 mm) 3 strand or 8 plait | 26 |
| HRC 8 | 6074/5 | 8 mm | 9/16" (14 mm) 3 strand or 8 plait | 27 |
| HRC 8 | 6074/5 | 8 mm | 5/8" (16 mm) 3 strand or 8 plait | 28 |
| HRC 8 | 6086/7 | 5/16" | ½" (12 mm) 3 strand | 29 |
| HRC 8 | 6086/7 | 5/16" | ½" (12 mm) 8 plait | 30 |
| HRC 8 | 6086/7 | 5/16" | 9/16" (14 mm) 3 strand | 31 |
| HRC 8 | 6086/7 | 5/16" | 5/8" (16 mm) 3 strand | 32 |
| Liberty - 1000 Watt | 5220/P101525 | 3/8" (10 mm) | ¾" (20 mm) 3 strand | 7 |
| Liberty - 1000 Watt | 5220/P101525 | 3/8" (10 mm) | ¾" (20 mm) 8 plait | 8 |
| Liberty - 1000 Watt | 5346/P101542 | 5/16" | 5/8" (16 mm) 3 strand | 5 |
| Liberty - 1000 Watt | 5346/P101542 | 5/16" | 5/8" (16 mm) 8 plait | 6 |
| Liberty - 1000 Watt | 5443/P101547 | 8 mm | 5/8" (16 mm) 3 strand | 3 |
| Liberty - 1000 Watt | 5443/P101547 | 8 mm | 5/8" (16 mm) 8 plait | 4 |
| Liberty - 1200 Watt | 5220/P101525 | 3/8" (10 mm) | ¾" (20 mm) 3 strand | 13 |
| Liberty - 1200 Watt | 5220/P101525 | 3/8" (10 mm) | ¾" (20 mm) 8 plait | 14 |
| Liberty - 1200 Watt | 5346/P101542 | 5/16" | 5/8" (16 mm) 3 strand | 11 |
| Liberty - 1200 Watt | 5346/P101542 | 5/16" | 5/8" (16 mm) 8 plait | 12 |
| Liberty - 1200 Watt | 5443/P101547 | 8 mm | 5/8" (16 mm) 3 strand | 9 |
| Liberty - 1200 Watt | 5443/P101547 | 8 mm | 5/8" (16 mm) 8 plait | 10 |
| Liberty - 1500 Watt | 5220/P101525 | 3/8" (10 mm) | ¾" (20 mm) 3 strand | 19 |
| Liberty - 1500 Watt | 5220/P101525 | 3/8" (10 mm) | ¾" (20 mm) 8 plait | 20 |
| Liberty - 1500 Watt | 5346/P101542 | 5/16" | 5/8" (16 mm) 3 strand | 17 |
| Liberty - 1500 Watt | 5346/P101542 | 5/16" | 5/8" (16 mm) 8 plait | 18 |
| Liberty - 1500 Watt | 5443/P101547 | 8 mm | 5/8" (16 mm) 3 strand | 15 |
| Liberty - 1500 Watt | 5443/P101547 | 8 mm | 5/8" (16 mm) 8 plait | 16 |
| RC10 | P103309 | 3/8" (10mm) | 5/8" (16 mm) 3 strand | 43 |

MUIR ROPE & CHAIN WINDLASSES

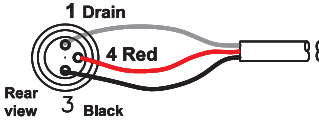

| Windlass Model | Voltage | Chainwheel Reference | Chain Size | Rope Size | AutoAnchor Reference |
|----------------------|---------|----------------------|------------------|------------------------|----------------------|
| Atlantic 600 | 12V | 116 | 1/4" (6 mm) | 1/2" (12 mm) 3 strand | 68 |
| Atlantic 600 | 12V | 117 | 1/4" (6 mm) | 1/2" (12 mm) 3 strand | 69 |
| Atlantic 850 | 12V | 66 | 1/4" (6 mm) | 1/2" (12 mm) 3 strand | 70 |
| Atlantic 850 | 12V | 80 | 5/16" (8 mm) | 1/2" (12 mm) 3 strand | 85 |
| Atlantic 850 | 12V | 80 | 5/16" (8 mm) | 9/16" (14 mm) 3 strand | 72 |
| Atlantic 850 | 12V | 99 | 3/8" (10 mm) | 5/8" (16 mm) 3 strand | 73 |
| Atlantic 850 | 12V | 112 | 3/8" (10 mm) | 5/8" (16 mm) 3 strand | 71 |
| Atlantic 850 | 12V | 120 | 5/16" (8 mm) | 9/16" (14 mm) 3 strand | 86 |
| Atlantic 850 | 12V | 120 | 5/16" (8 mm) | 9/16" (14 mm) 3 strand | 74 |
| Atlantic 1000/1250 | 12/24V | 66 | 1/4" (6 mm) | 1/2" (12 mm) 3 strand | 75 |
| Atlantic 1000/1250 | 12/24V | 80 | 5/16" (8 mm) | 9/16" (14 mm) 3 strand | 77 |
| Atlantic 1000/1250 | 12/24V | 99 | 3/8" (10 mm) | 5/8" (16 mm) 3 strand | 78 |
| Atlantic 1000/1250 | 12/24V | 112 | 3/8" (10 mm) | 5/8" (16 mm) 3 strand | 76 |
| Atlantic 1000/1250 | 12/24V | 120 | 5/16" (8 mm) | 9/16" (14 mm) 3 strand | 79 |
| Atlantic 1200 | 12/24V | 66 | 1/4" (6 mm) | 1/2" (12 mm) 3 strand | 80 |
| Atlantic 1200 | 12/24V | 80 | 5/16" (8 mm) | 9/16" (14 mm) 3 strand | 82 |
| Atlantic 1200 | 12/24V | 99 | 3/8" (10 mm) | 5/8" (16 mm) 3 strand | 83 |
| Atlantic 1200 | 12/24V | 112 | 3/8" (10 mm) | 5/8" (16 mm) 3 strand | 81 |
| Atlantic 1200 | 12/24V | 120 | 5/16" (8 mm) | 9/16" (14 mm) 3 strand | 84 |
| Atlantic 2200 | 12/24V | 80 | 5/16" (8 mm) | 9/16" (14 mm) 3 strand | 88 |
| Atlantic 2200 | 12/24V | 99 | 3/8" (10 mm) | 5/8" (16 mm) 3 strand | 89 |
| Atlantic 2200 | 12/24V | 112 | 3/8" (10 mm) | 5/8" (16 mm) 3 strand | 87 |
| Atlantic 2500 | 12/24V | 57 | 5/16" (8mm) | 5/8" (16 mm) 3 strand | 90 |
| Atlantic 2500 | 12/24V | 60 | 3/8" (10 mm) HT | 3/4" (19 mm) 3 strand | 92 |
| Atlantic 2500 | 12/24V | 61 | 3/8" (10 mm) BBB | 3/4" (19 mm) 3 strand | 93 |
| Atlantic 2500 | 12/24V | 114 | 1/2" (12.5mm) | 7/8" (22mm) 3 strand | 94 |
| Atlantic 2500 | 12/24V | 119 | 3/8"(10 mm) | 3/4" (19 mm) 3 strand | 97 |
| Atlantic 2500 | 12/24V | 121 | 5/16" (8 mm) | 5/8" (16 mm) 3 strand | 91 |
| Atlantic 2500 | 12/24V | 130 | 13 mm | 7/8" (22 mm) 3 strand | 96 |
| Atlantic 2500 | 12/24V | 131 | 1/2" (12.5 mm) | 7/8" (22 mm) 3 strand | 94 |
| Atlantic 3500 | 12/24V | 60 | 3/8" (10 mm) HT | 3/4" (19 mm) 3 strand | 100 |
| Atlantic 3500 | 12/24V | 61 | 3/8" (10 mm) BBB | 3/4" (19 mm) 3 strand | 101 |
| Atlantic 3500 | 12/24V | 114 | 1/2" (12.5 mm) | 7/8" (22 mm) 3 strand | 102 |
| Atlantic 3500 | 12/24V | 119 | 3/8"(10 mm) | 3/4" (19 mm) 3 strand | 99 |
| Atlantic 3500 | 12/24V | 130 | 13 mm | 7/8" (22 mm) 3 strand | 103 |
| Atlantic 3500 | 12/24V | 131 | 1/2" (12.5mm) | 7/8" (22 mm) 3 strand | 102 |
| Atlantic 4000(1500W) | 12V | 60 | 3/8" (10 mm) HT | 3/4" (19 mm) 3 strand | 105 |
| Atlantic 4000(1500W) | 12V | 61 | 3/8" (10 mm) BBB | 3/4" (19 mm) 3 strand | 106 |
| Atlantic 4000(1500W) | 12V | 119 | 3/8" (10 mm) | 3/4" (19 mm) 3 strand | 104 |
| Atlantic 4000(1500W) | 12V | 130 | 13 mm | 7/8" (22 mm) 3 strand | 110 |
| Atlantic 4000(2000W) | 24V | 60 | 3/8" (10 mm) HT | 3/4" (19 mm) 3 strand | 108 |
| Atlantic 4000(2000W) | 24V | 61 | 3/8" (10 mm) BBB | 3/4" (19 mm) 3 strand | 109 |
| Atlantic 4000(2000W) | 24V | 114 | 1/2" (12.5 mm) | 7/8" (22 mm) 3 strand | 112 |
| Atlantic 4000(2000W) | 24V | 119 | 3/8" (10 mm) | 3/4" (19 mm) 3 strand | 107 |
| Atlantic 4000(2000W) | 24V | 130 | 13 mm | 7/8" (22 mm) 3 strand | 111 |
| Atlantic 4000(2000W) | 24V | 131 | 1/2" (12.5 mm) | 7/8" (22 mm) 3 strand | 112 |

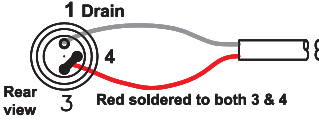
AutoAnchor Sensor Wiring - Use the Plug In Sensor Connector Cables

Field Connectors for Plug - Used if the sensor or console does not have plugs.

| | | | |
|--|---|---|--|
| <p>Grey 3 Wire AutoAnchor Sensor (#9067)</p> <p>Suitable for Chain only or Combined Rope and Chain Rods</p> | <p>Female Field Connector (#9509)</p>  |  | <p>Grey 3 Wire AutoAnchor Sensor (#9067)</p> |
| <p>Black 2 Wire (#9008) or White 2 Wire (#9078) AutoAnchor Sensor</p> | <p>Female Field Connector (#9509)</p>  |  | <p>Black 2 Wire (#9008) or White 2 Wire (#9078) AutoAnchor Sensor</p> |
| <p>Reed Switch Sensor</p> | <p>Female Field Connector (#9509)</p>  |  | <p>Reed Switch Sensor</p> |

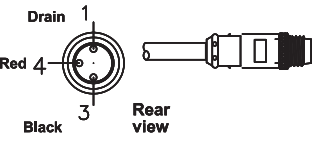
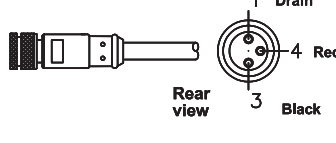
Sensor Cable Joins

| | | |
|---|--|--|
| <p>Male Field Connector #9507</p>  | <p>Female Field Connector #9509</p>  | <p>Exploded Field Connector Assembly Example</p>  |
|---|--|--|

Cable Connections without Plugs

If the AutoAnchor plug in connectors are not used the cable joins must be solder spliced and sealed in heat shrink tubing. The entire splice must be water proof. Sensor cable must be Beldon 8501 (24 AWG) or equivalent.

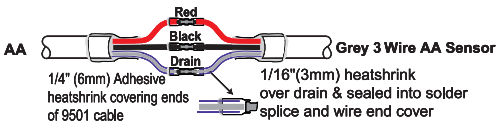
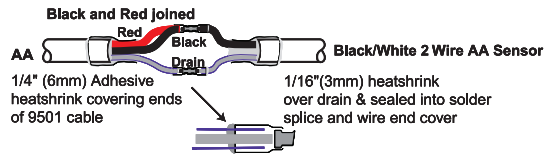
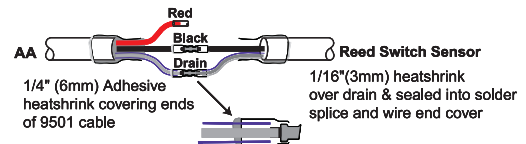
| | |
|--|--|
| <p>Sensor Cable Splice Using the Grey 3 Wire AutoAnchor Sensor (#9067)</p> <p>Ensure all wires are matched and connected including the screen/drain wire. All connections must be made for the unit to operate.</p> |  |
| <p>Sensor Cable Splice Using the Black (#9008) or White (#9078) AutoAnchor Sensor</p> |  |
| <p>Sensor Cable Splice Using a Reed Switch Sensor</p> <p>When connecting the reed switch sensor to the AA, the red wire is not connected.</p> |  |

AA702A.1: WINDLASS CHAIN ONLY WIRING FOR 7021703 BASE STATION SYSTEMS

AA702A Base Station Internal Connections

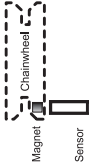

Note:
Base station must be positioned to allow internal access during and after installation

| | |
|----------------|-----|
| AA702 TERM | (-) |
| BATT | (+) |
| OUT 1 | (+) |
| OUT 2 | (+) |
| OUT 3 | (+) |
| OUT 4 | (+) |
| OUT 5 White | (+) |
| OUT 6 Brown | (+) |

REFER TO SECTION 2.4.1

Notes:
Unused outputs are automatically assigned as auxiliary outputs
See owners manual section for more details
All outputs are active high (+)

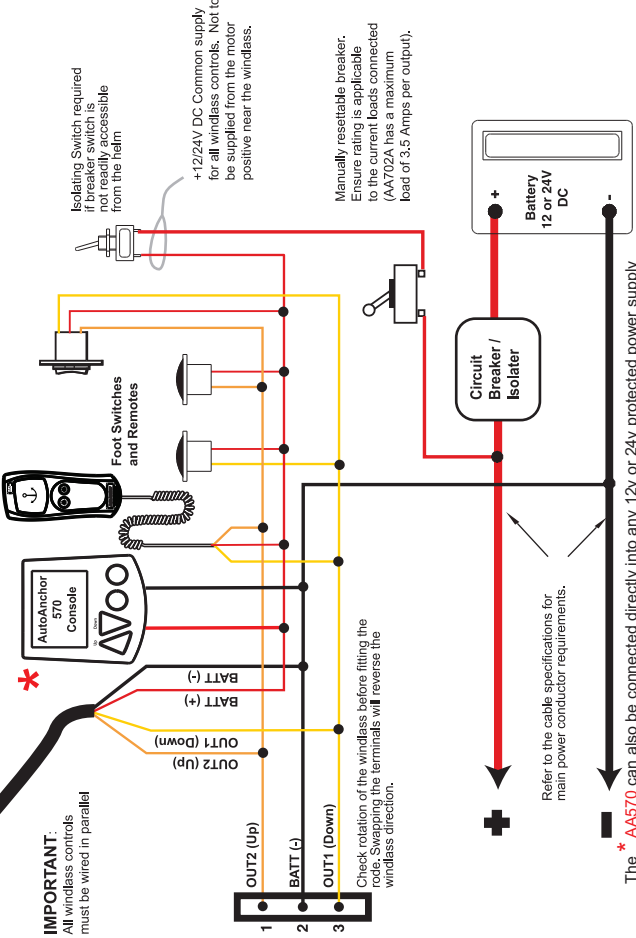
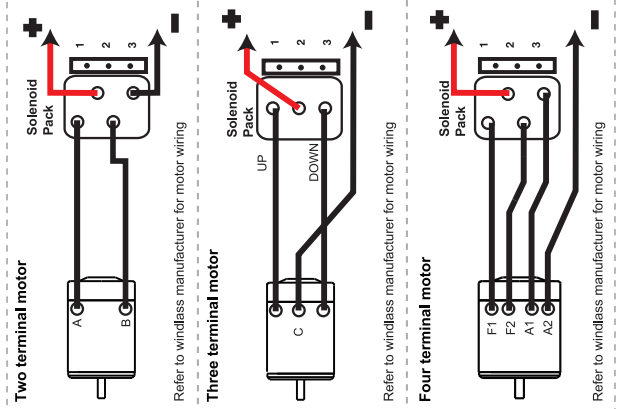

AA702A.2: WINDLASS ROPE AND CHAIN WIRING FOR 702/703 BASE STATION SYSTEMS

AA702A Base Station Internal Connections

| | | |
|------------|-----------|-----|
| AA702 TERM | BATT | (-) |
| BATT | (+) | |
| OUT 1 | (+) | |
| OUT 2 | (+) | |
| OUT 3 | (+) | |
| OUT 4 | (+) | |
| OUT 5 | White (+) | |
| OUT 6 | Brown (+) | |

REFER TO SECTION 2.4.1

Notes:
 Unused outputs are automatically assigned as auxiliary outputs
 See owner's manual section for more details
 All outputs are active high (+)



Note:
 Base station must be positioned to allow internal access during and after installation

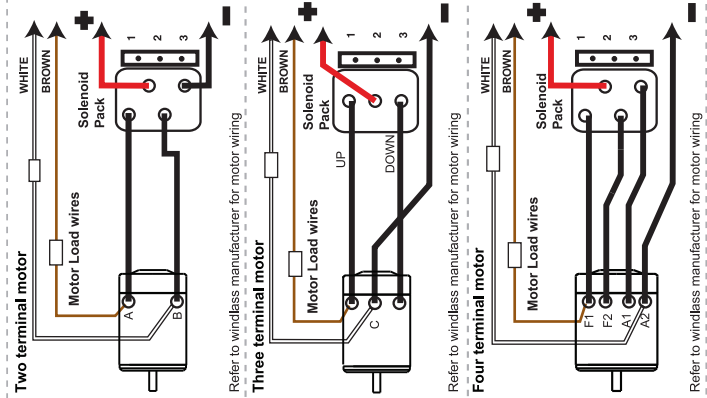

IMPORTANT
 All windless controls must be wired in parallel

The brown wire must connect direct to the UP (+) motor terminal

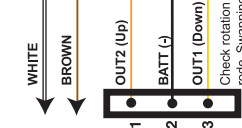

Check rotation of the windlass before fitting the rope. Swapping the terminals will reverse the windless direction.

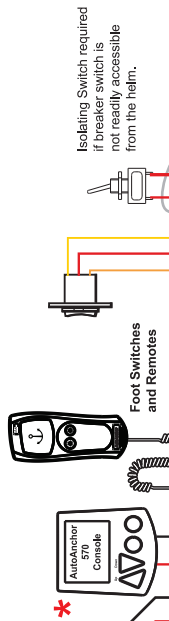

+12/24V DC
 Common supply for all windlass controls. Not to be supplied from the motor positive near the windlass.

Manually resettable breaker. Ensure rating is applicable to the current loads connected (AA702A: □ has a maximum load of 3.5 Amps per output).

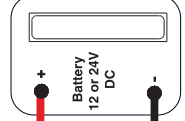

Refer to the cable specifications for main power conductor requirements.

*** AA570 can also be connected directly into any 12v or 24v protected power supply INSTALLATIONS MUST BE CARRIED OUT IN ACCORDANCE WITH USCG, ABYC, NIMA and BMECA REQUIREMENTS**

AA702A.3: AC, HYDRAULIC AND PLC ALL CHAIN WIRING FOR 702/703 BASE STATION SYSTEMS

AA702A Base Station Internal Connections

| AA702 TERM | Color | Terminal |
|------------|-------|-------------|
| BATT | (-) | BATT (-) |
| OUT 1 | (+) | OUT 1 (+) |
| OUT 2 | (+) | OUT 2 (+) |
| OUT 3 | (+) | OUT 3 (+) |
| OUT 4 | (+) | OUT 4 (+) |
| OUT 5 | (+) | OUT 5 White |
| OUT 6 | (+) | OUT 6 Brown |

REFER TO SECTION 2.4.1

Notes:
 * All outputs are automatically assigned as auxiliary outputs before fitting the rode. Swapping the terminals will reverse the windlass direction.
 * All outputs are active high (+)



Note:
 Base station must be positioned to allow internal access during and after installation

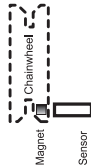

Example windlass drives

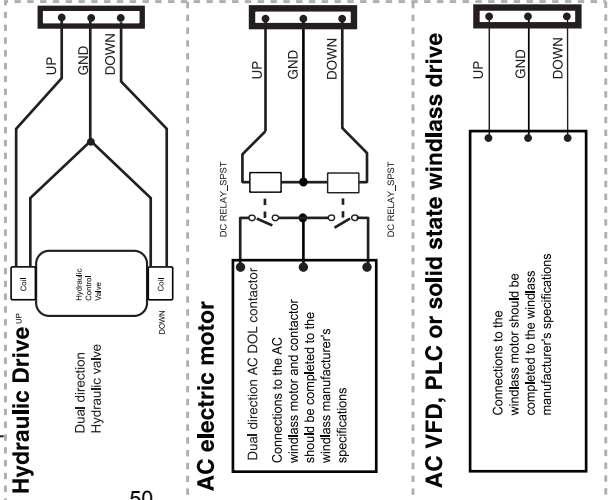

IMPORTANT
 All windlass controls must be wired in parallel

*



Check rotation of the windlass before fitting the rode. Swapping the terminals will reverse the windlass direction.

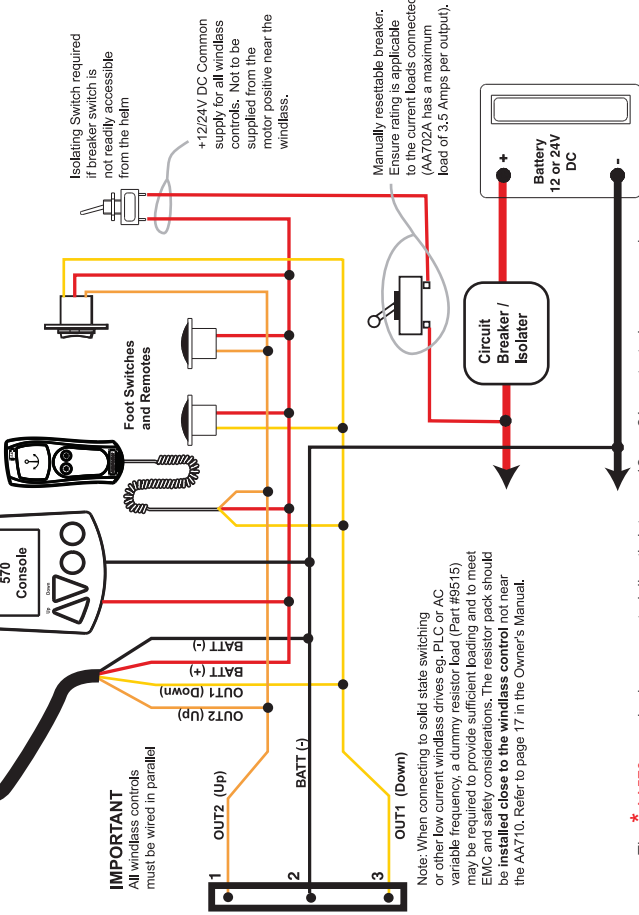

Note: When connecting to solid state switching or other low current windlass drives eg. PLC or AC variable frequency, a dummy resistor load (Part #9515) may be required to provide sufficient loading and to meet EMC and safety considerations. The resistor pack should be installed close to the windlass control not near the AA710. Refer to page 17 in the Owner's Manual.

WARNING: Power must be disconnected during installation and when making any changes to wiring after installation.

* The AA570 can also be connected directly into any 12v or 24v protected power supply INSTALLATIONS MUST BE CARRIED OUT IN ACCORDANCE WITH USCG, ABYC, NIMMA and BMEA REQUIREMENTS

AA702A.4: EXAMPLE THRUSTER WITH WINDLASS WIRING FOR AA710 | 730 SYSTEM

Windlass and Two thrusters

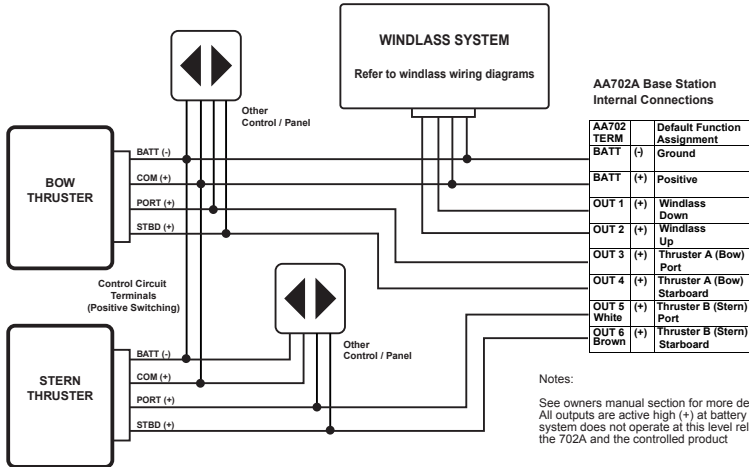

Two thrusters with power enable

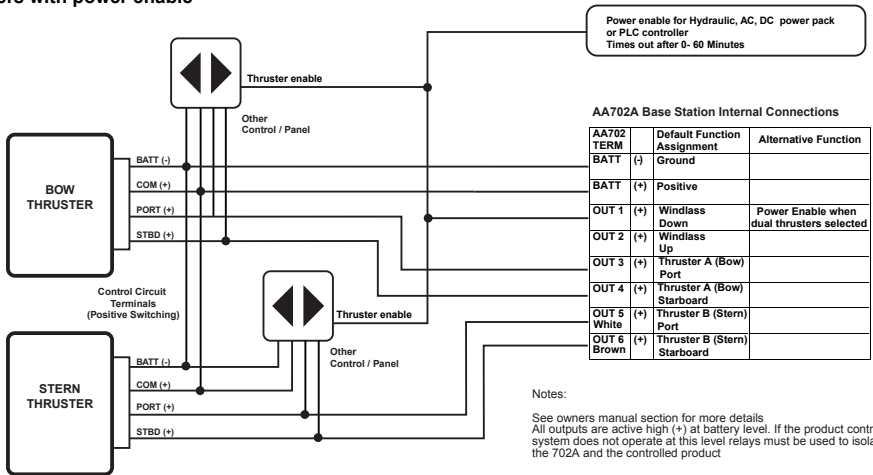

IMPORTANT NOTES:

1. Refer to thruster manufacturers' specifications for fuse/breaker and isolator requirements.
2. Refer to thruster manufacturers' specifications for main power cable specifications.
3. An additional isolating switch should be installed for controls if the main breaker or isolator is not readily accessible from the helm.
4. If thruster control circuit uses negative switching, connect a relay between the AA702A output and the control wire to convert from positive to negative switching.
5. Base Station must be positioned to allow internal access during and after installation.
6. Stern and Bow output locations stated are the default locations. These can be swapped in the AA710-6 system setup menu.
7. There must be an alternative method available to operate the windlass, thruster or other equipment. A failure of the wireless link will result in loss of control of the equipment via the AA710-6.
8. Installations must be carried out in accordance with USCG, ABYC, NMMA and BMEA requirements.

WARNING:

Power must be disconnected during installation and when making any changes to wiring after installation.

AA702 Base Station Internal Connections

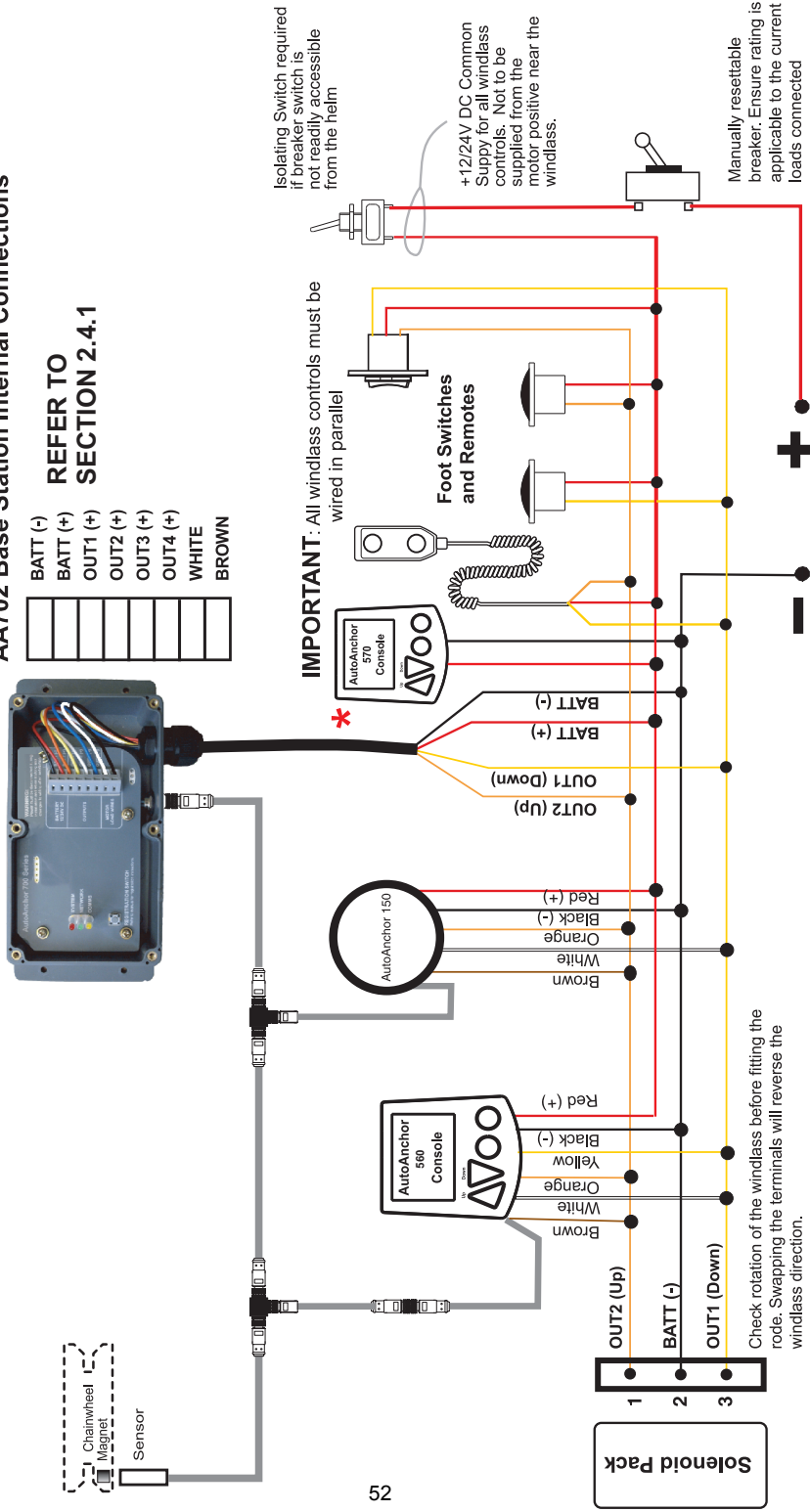

REFER TO SECTION 2.4.1

- BATT (+)
- BATT (-)
- OUT1 (+)
- OUT2 (+)
- OUT3 (+)
- OUT4 (+)
- WHITE
- BROWN

IMPORTANT: All windlass controls must be wired in parallel

Isolating Switch required if breaker switch is not readily accessible from the helm

+12/24V DC Common Supply for all windlass controls. Not to be supplied from the motor positive near the windlass.

Manually resettable breaker. Ensure rating is applicable to the current loads connected

Check rotation of the windlass before fitting the rode. Swapping the terminals will reverse the windlass direction.

The * AA570 can also be connected directly into any 12v or 24v protected power supply

ROPE AND CHAIN WIRING FOR MULTIPLE AA 570, 710, 730 PRODUCTS

AA702A Base Station Internal Connections

| AA702 TERM | Color |
|------------|-------|
| BATT (-) | (-) |
| BATT (+) | (+) |
| OUT 1 | (+) |
| OUT 2 | (+) |
| OUT 3 | (+) |
| OUT 4 | (+) |
| OUT 5 | (+) |
| OUT 6 | (+) |

REFER TO SECTION 2.4.1

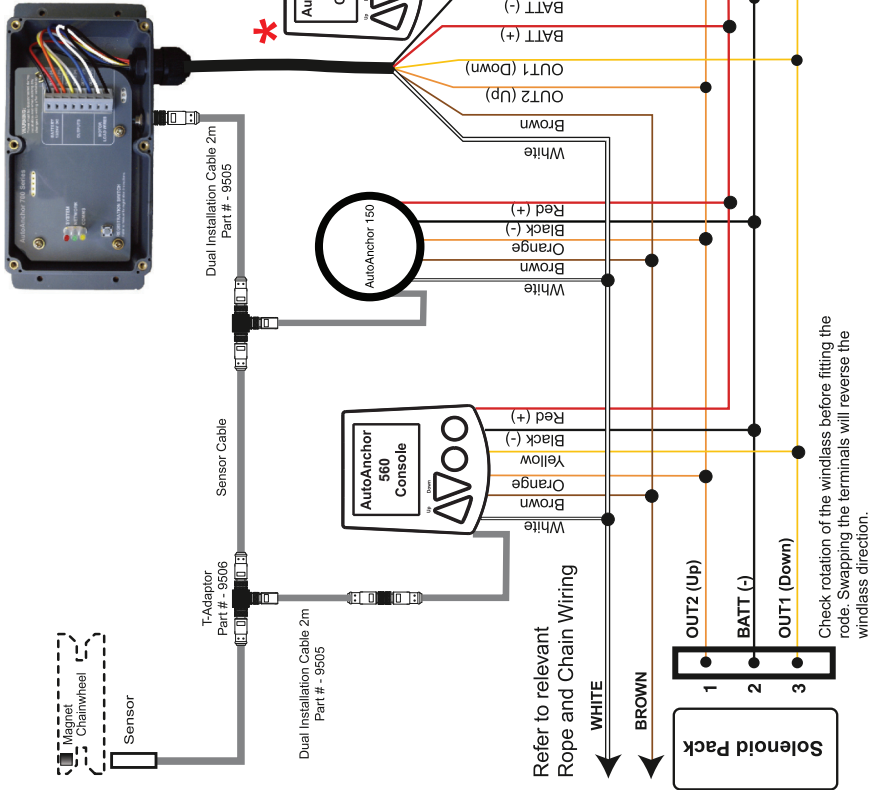

Notes:
 Unused outputs are automatically assigned as auxiliary outputs
 for more details
 All outputs are active high (+)

IMPORTANT
 All windlass controls must be wired in parallel

Isolating Switch required if breaker switch is not readily accessible from the helm

Refer to relevant Rope and Chain Wiring

Check rotation of the windlass before fitting the rode. Swapping the terminals will reverse the windlass direction.

Manually resettable breaker. Ensure rating is applicable to the current loads connected

* AA570 can also be connected directly into any 12v or 24v protected power supply
 INSTALLATIONS MUST BE CARRIED OUT IN ACCORDANCE WITH USCG, ABYC, NIMMA and BIMEA REQUIREMENTS

WARNING: Power must be disconnected during installation and when making any changes to wiring after installation

AutoAnchor Product Warranty

Kiwi Yachting Consultants Limited
PO Box 90114
Victoria St West
Auckland 1142
New Zealand

Phone: +64 09 360 0300
Fax: +64 9 360 0302
Australia: 1800 201 853
Email: sales@autoanchor.co.nz
Web: www.autoanchor.co.nz



**A Kiwi Yachting
Company**

KYC Limited warrants all AutoAnchor products against defects in materials and workmanship for 3 years under normal use.

Provided KYC receives notice of such defects during the warranty period KYC will, at its option, either repair or replace products that prove to be defective.

Determination of the suitability of the product for the use contemplated by the buyer is the sole responsibility of the buyer and KYC shall have no responsibility in connection with such suitability.

Warranty does not apply to defects resulting from:
Improper or inadequate installation, maintenance or calibration;
Unauthorised modification of the product;
Misuse of the product;
Operation outside the published specifications for the product;
Corrosion, wear and tear.

KYC shall not be responsible for shipping charges or installation labour associated with any warranty claims.

KYC shall not be liable for consequential damages to any vessel, equipment or other property or person due to use or installation of an AutoAnchor product.

The warranty period applies from the date of purchase. Proof of purchase is required when claiming under warranty.

Any statements contained on KYC's website or in its marketing literature shall not be deemed to widen KYC's obligations under this warranty.

To make a claim under warranty contact KYC or your supplier.

To be eligible for warranty protection please complete the warranty form below and post to the address above.

Purchaser

| | |
|------------|------------|
| Name: | |
| Telephone: | Facsimile: |
| Email: | |

| |
|---------|
| Address |
|---------|

Supplier/Dealer

| | |
|------------|------------|
| Name: | |
| Telephone: | Facsimile: |
| Email: | |

| |
|---------|
| Address |
|---------|

Auto Anchor Model

| |
|--|
| |
| |

Serial Number

| |
|--|
| |
| |

| |
|------------------|
| Date of purchase |
|------------------|

| |
|-----------|
| Boat Type |
|-----------|

| |
|----------------|
| Windlass Model |
|----------------|

| | |
|---------------|--------|
| Name of Boat: | L.O.A. |
|---------------|--------|

| |
|----------|
| Built by |
|----------|

INDEX

| | | | |
|--------------------------------------|-----------|----------------------------------|-------|
| Allocate Modes | 20 | Important Information | 2 |
| Anchoring | 30-33 | Indicators, LED | 16 |
| Auto Wash | 18 | Information Displayed | 28 |
| Auto Windlass Operation | 31 | Installation | 4-16 |
| Auxiliary | | Auxiliary Equipment | 11 |
| Example Set Up | 22 | Base Station | 12-13 |
| Operation | 37 | Console | 13 |
| Settings | 19 | Deck Socket | 13 |
| Backlighting | 18 | Diagnostics | 38 |
| Base Station | | Drum Winch | 10 |
| Connecting Cables | 15 | Horizontal Windlass | 9-10 |
| Installation | 12-14 | Magnet and Sensor | 4-10 |
| Output Options | 20 | Multiple AA Installations | 16 |
| Resetting Factory Defaults | 16 | Plug and Play Sensor | 5 |
| Buttons | 16,28 | Remote Console | 13 |
| Changing Mode | 29 | Thruster | 11 |
| Lock | 29 | Vertical Windlass | 7-8 |
| To Turn Off and On | 28 | Windlass | 4-10 |
| Cable | | Key Beep Set Up | 18 |
| Cable Connections to Base Station | 15 | Keys | |
| Cable Specifications | 14 | Changing Modes | 29 |
| Plug and Play Sensor | 5 | Lock | 29 |
| Calculating chain per turn | 24 | To Turn Off and On | 28 |
| Calculating rope per turn | 25 | Using the Keys | 16,28 |
| Chain Counting | | Language Set Up | 17 |
| Windlass Set Up | 23-27 | LED Indicators | 16 |
| Clear to Zero | 33 | Lock | 29 |
| Connecting the AA703 | | Reset lock manually | 29 |
| Base Station Wires | 14-15 | Low Current Drives | 15 |
| Connecting the Console to the | | Maintenance | 38 |
| Base Station | 28 | Magnet | 4-10 |
| Console | | Installing Horizontal Windlass | 9-10 |
| Buttons | 16,28 | Installing Vertical Windlass | 7-8 |
| Connection | 28 | Polarity | 4 |
| Installation | 12 | Multiple AA Installations | 15 |
| Deck Socket Installation | 13 | Modes | |
| Deploying the Anchor | 30-33 | Allocate | 20 |
| Docking Distance Set Up | 23 | Auxiliary | 22 |
| Docking Alarm | 31 | Changing | 29 |
| Drum Winch | | Power Enable | 19 |
| Installation | 10 | Set Up | 18-22 |
| Set Up | 26-27 | Thruster | 19 |
| Dual Speed Windlass | 32 | Windlass | 18 |
| Electromagnetic Compatibility | 3 | Operation | 28-37 |
| Example Mode Set Ups | 21-22 | Anchoring | 30-33 |
| General Set Up | 17 | Automatic | 30-32 |
| Factory Defaults Reset | 16 | Check Logs | 33 |
| Horizontal Windlass | 9-10 | Clear to Zero | 33 |
| | | Dual Speed | 32 |
| | | Manual | 31 |
| | | Options A and B | 33 |

| | | | |
|-------------------------------------|-----------|---------------------------------------|--------------|
| Auxiliary Equipment | 37 | Rode | 23-26 |
| Change Modes | 29 | Sensor | 27,30 |
| Thruster | 34-36 | Swap Controls | 27 |
| Plug & Play Sensor Cable | 5 | System Overview | 17 |
| Plug & Play Sensor Tuning | 30 | Thruster | 19 |
| Power Supply | 13 | Total Rode Length | 23 |
| Voltage Levels | 14 | Units | 17 |
| Reset Sensor | 33 | Windlass | 23-27 |
| Reset Factory Defaults | 16 | Specifications Technical | 3 |
| Retrieving the Anchor | 30-33 | Swap Controls | 27 |
| Rode | | System Overview | 17 |
| Chain only | 3,24 | Technical Specifications | 3 |
| Calculating chain per turn | 24 | Testing | 29 |
| Set Up | 24 | Thruster | |
| Rope and Chain | 3,25 | Bow and Stern Thruster | 34-36 |
| Calculating chain per turn | 24,25 | Installation | 11 |
| Calculating rope per turn | 25 | Operation | 34-36 |
| Set Up | 25-26 | Set Up Examples | 19 |
| Safety Override | 31 | Using the Thruster | 34-36 |
| Sensor | | Total Rode Length | 23 |
| Cable | 5 | Troubleshooting | 38-42 |
| Connection | 5 | Turn On and Off | 28 |
| Dual Installation | 6 | Units Set up | 17 |
| Gap | 4-10 | User Precautions | 29 |
| Holder | 9 | Using the Buttons | 16,28 |
| Installation | 4-10 | Turn Off | 28 |
| Position | 4-10 | Turn On | 28 |
| Plug in Connections | 5 | Vertical Windlass Installation | 7-8 |
| Reed Switch | 6 | Voltage | 14 |
| Reset | 33 | Windlass | |
| Set Up | 27 | Operation | 30-33 |
| Tuning | 30 | Horizontal Installation | 9-10 |
| Set Up | 17-27 | Installation | 4-10 |
| Auxiliary Equipment | 22 | Vertical Installation | 7-8 |
| Backlighting | 18 | Wiring | 14,15 |
| Docking Distance | 23 | Low Current Drives | 15 |
| Examples | 21-22 | Motor Load Wires | 14 |
| General | 17 | Multiple AA Installation | 15 |
| Key Beep | 18 | To Connect the Wires | 15 |
| Language | 17 | Wiring Diagrams | 47-53 |
| Menu Overview | 17 | | |
| Modes | 24-29 | | |



**A Kiwi Yachting
Company**

The AutoAnchor is designed and manufactured by:

Kiwi Yachting Consultants Ltd
PO Box 90114, Auckland Mail Centre, Auckland, New Zealand
Ph: +64 9 360 0300 Email: support@autoanchor.co.nz

AutoAnchor is a trademark of Kiwi Yachting Consultants Limited Copyright © 2013,
Kiwi Yachting Consultants Limited, New Zealand



AA730OWN B